

Public seating

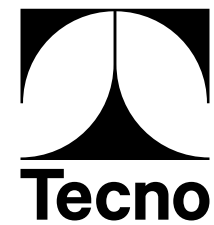

Tecno has worked in many high traffic areas around the world, giving precision to urban interchange spaces, which are increasingly fluid, whether large waiting halls in railway stations and airports or tram routes and underground lines. Today Tecno develops product systems which stand out for their aesthetics and technical features, in response to social change and new behaviours in mobility.

Tecno si è confrontata con molteplici aree ad alto traffico in tutto il mondo, dando esattezza agli spazi pubblici urbani di interscambio, sempre più fluidi: che siano le grandi hall di attesa di stazioni e aeroporti o i percorsi delle linee metropolitane e tranviarie. Oggi sviluppa sistemi prodotti distintivi sia sotto il profilo estetico che per caratteristiche tecniche, intercettando i cambiamenti sociali e i nuovi comportamenti connessi al movimento.

Public seating

Sedute per spazi pubblici

**Aeris, Archipelago,
Aura, D70, Laetitia,
Linea, Pax, P32,
P40, Pons, RS, RS2,
Todo Modo.**

Public seating

Sedute per spazi pubblici

Airports and railway stations 9

Aeroporti e stazioni

Lounges 73

Lounge

Airports and railway stations are by now more than simple points of transit, but also multicultural urban areas, transverse and dynamic, in which people spend their time, not simply waiting to move on to the next destination, but in different activities, including work. In such high traffic areas, furnishings must be comfortable and flexible, adapted to a wide range of users, able to answer a variety of needs and equipped with technological features for connected passengers.

Aeroporti e stazioni non sono più solo luoghi di transito ma ambienti urbani multiculturali, trasversali e dinamici in cui le persone passano il tempo, non solo in attesa ma svolgendo diverse attività e spesso lavorando. In queste aree così frequentate, agli arredi è richiesto di essere confortevoli e flessibili, adatti a diversi tipi di utenti, in grado di rispondere a molteplici esigenze e dotati di supporto tecnologico per il viaggiatore sempre connesso.

Aeris ₁₀

RS ₃₂

RS2 ₅₂

Aeris

Design:
Grimshaw
2017

Aeris is a seating system that allows alignment of up to 5 seats with the option of adding cantilever tables. The iconic star shape of the structural beam in extruded aluminium is the functional core of the system as well as an aesthetic element that characterises it. The ease of assembly the individual elements gives freedom in composing each segment of the bench, generating endless solutions that can be reconfigured as required. Simply removing the side cover and inserting the joint or connection module makes it possible to connect an unlimited number of benches to satisfy a wide range of layout requirements. The product has been designed to provide a high degree of customisation for truly bespoke projects.

Un programma di sedute su barra che permette di allineare fino a 5 sedute, con la possibilità di aggiungere tavolini cantilever. L'iconica forma a stella della barra strutturale in estruso di alluminio, oltre che elemento estetico caratterizzante, è il cuore funzionale del sistema. La facilità di fissaggio dei singoli elementi permette di comporre liberamente ogni segmento della panca, creando infinite composizioni riconfigurabili nel tempo. Attraverso la semplice rimozione della cover laterale e l'inserimento del giunto o del modulo di connessione, è possibile collegare un numero infinito di panche per soddisfare ogni esigenza di layout. Il prodotto è pensato per accogliere un alto grado di personalizzazione, da realizzare a progetto.





The one-piece structure of the polyurethane seat makes the entire composition dynamic and streamlined: the ergonomic design features a double-S profile for lumbar support, while the rounded profile of the front of the seat allows unimpeded circulation in the legs. The design of the seat means it welcomes the body's natural posture even for long waiting times.

Il disegno monoscocca della seduta in poliuretano integrale dona slancio e dinamicità all'intera composizione: lo studio ergonomico ha portato alla definizione di una sagoma a doppia S che fa da sostegno alla colonna vertebrale, mentre la smussatura frontale del sedile consente la corretta circolazione sanguigna alle gambe. Così progettata, la seduta permette di mantenere la naturale postura del corpo anche nelle situazioni di attesa prolungata.



The design, materials and finishes have been defined with care and a view to the greatest aesthetic and functional longevity. Aeris also enables simple maintenance and replacement of the individual elements, ensuring a long life cycle of the product.

Design, materiali e finiture sono stati accuratamente definiti in ottica di massima durabilità funzionale ed estetica. Aeris permette inoltre una facile manutenzione e sostituzione dei singoli elementi, garantendo un lungo ciclo di vita del prodotto.

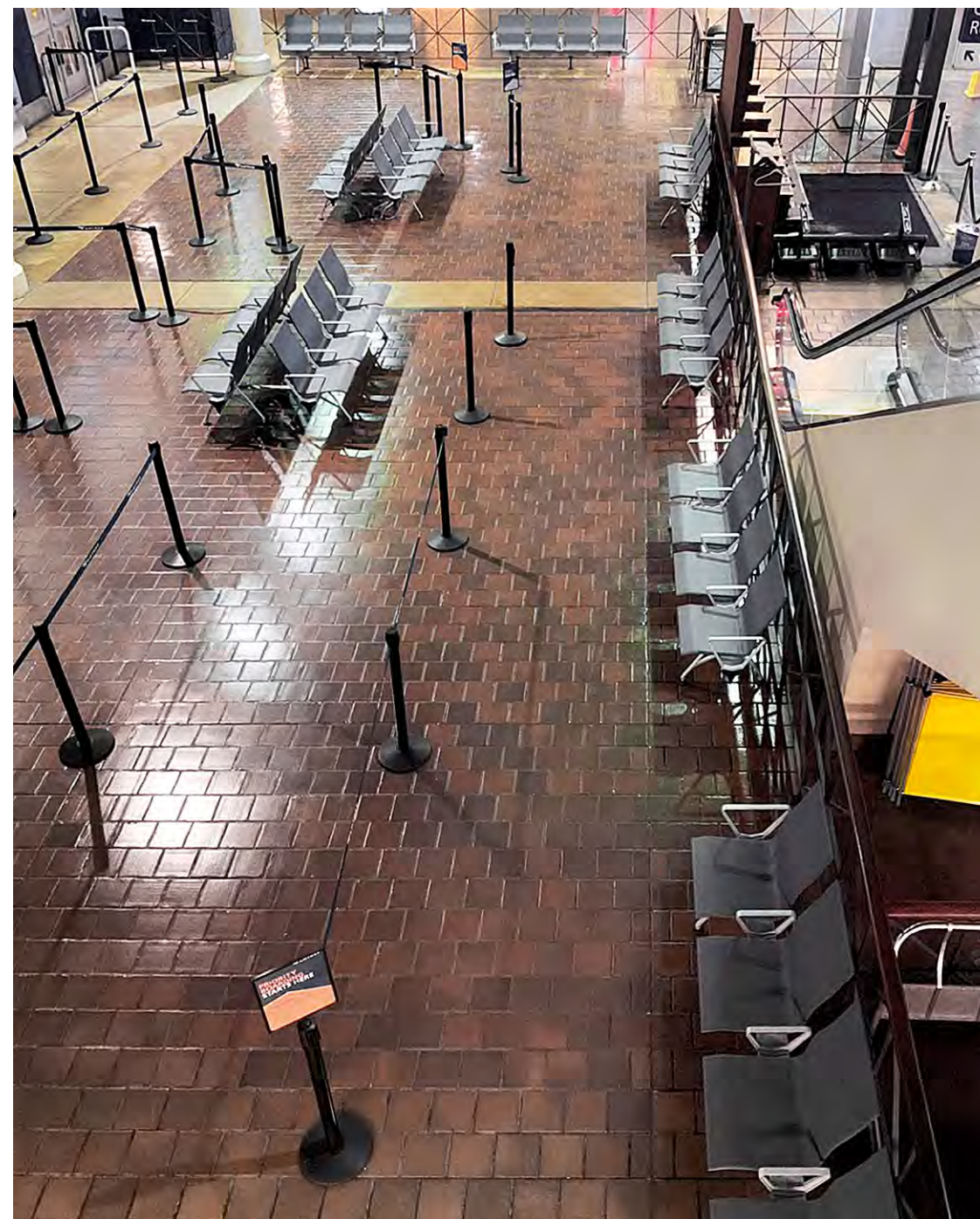

Standard seat
Seduta standard

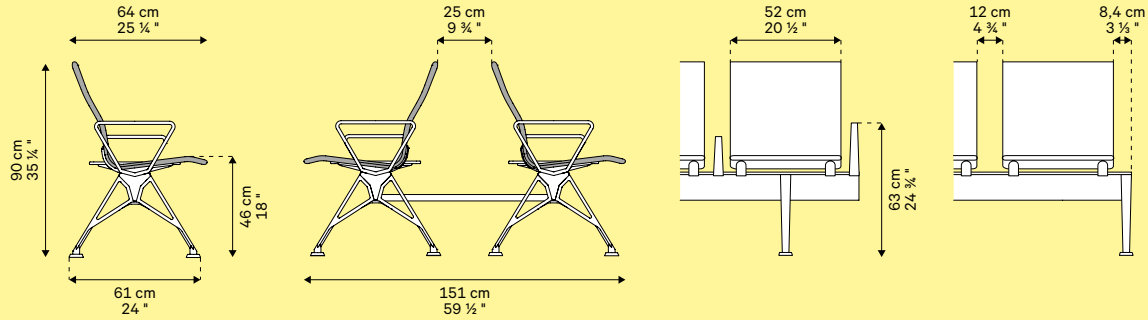

Chaise longue
Seduta recliner

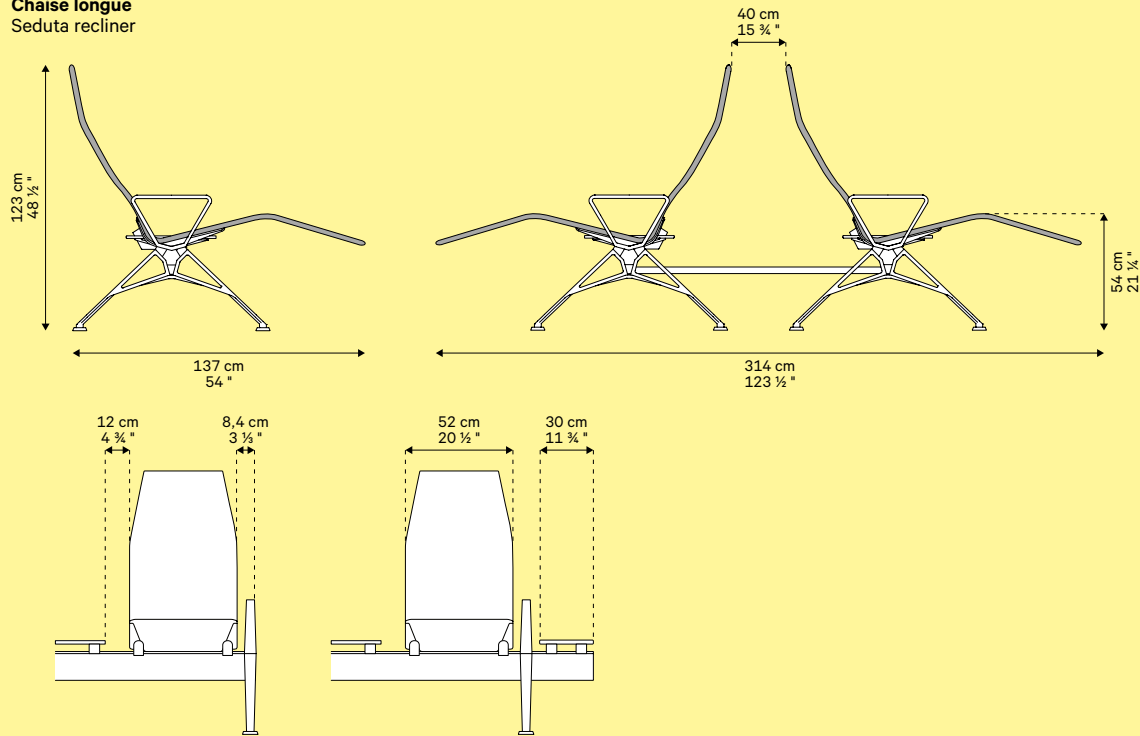

Backless seat
Panchetto

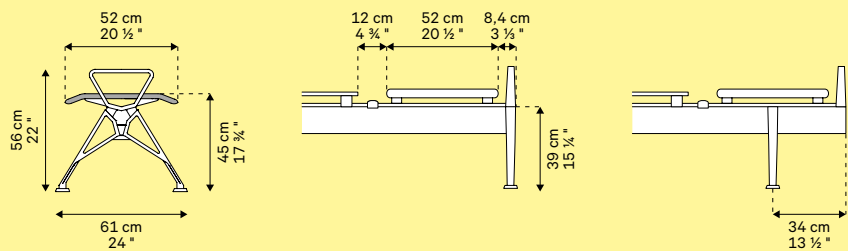

Bench configurations with standard seats, armrests and external legs
Configurazioni di panche con sedute standard con braccioli gamba esterna

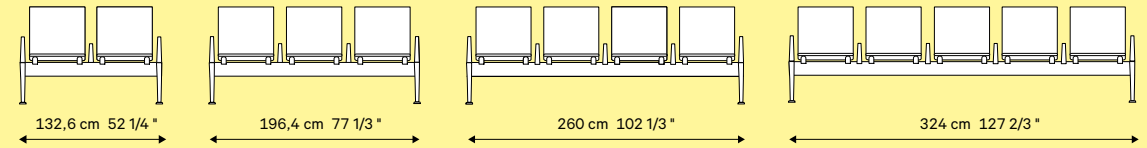

Bench configurations with standard seats, coffee tables and inner legs
Configurazioni di panche con sedute standard, tavolino e con gamba interna

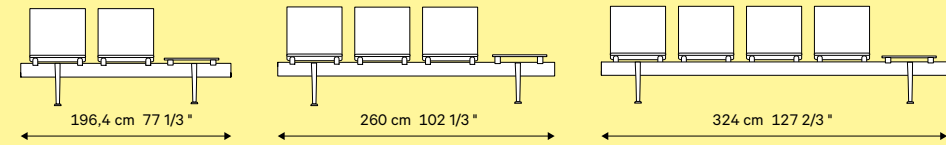

Bench configurations with backless seats, armrests, coffee tables and external legs
Configurazioni di panche con sedute panchetto, braccioli, tavolini e con gamba esterna

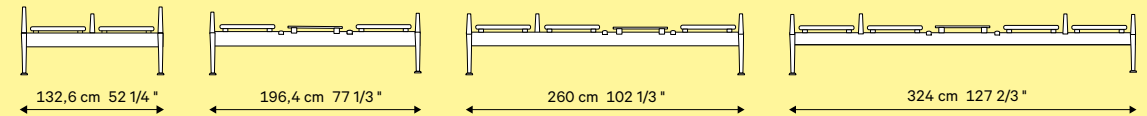

Bench configurations with recliner seats, armrests, coffee tables and external legs
Configurazioni di panche con sedute recliner, braccioli, tavolini e con gamba esterna

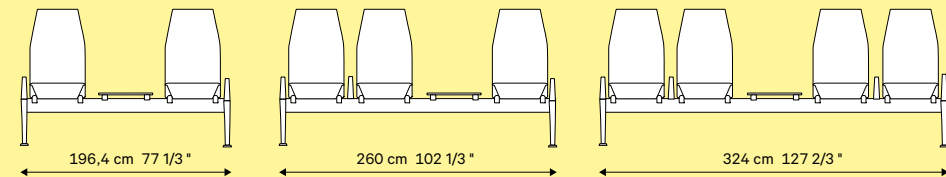

Bench configuration examples with mixed elements
Esempi di configurazioni di panche con caratteristiche miste

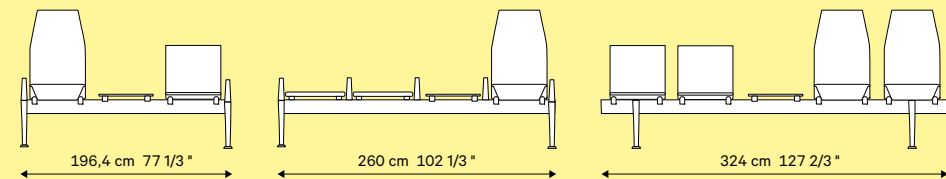

The legs and armrests have been designed to provide the highest degree of strength and solidity, with an outstanding lightness. The armrests are available at two different heights to offer comfort for all users. The seat is available in polyurethane integral skin, perforated metal, wood and upholstered in fabric and leather.

Gambe e braccioli sono studiati per assicurare il più alto grado di resistenza e solidità e trasmettere al contempo un effetto di massima leggerezza. I braccioli sono disponibili in due altezze per garantire livelli di comfort diversificati. La seduta è prevista nelle versioni in poliuretano integrale, lamiera forata, legno oppure rivestita in tessuto, pelle e cuoio.

Exploded view of all Aeris seating system elements.

Esploso dei componenti del sistema Aeris.

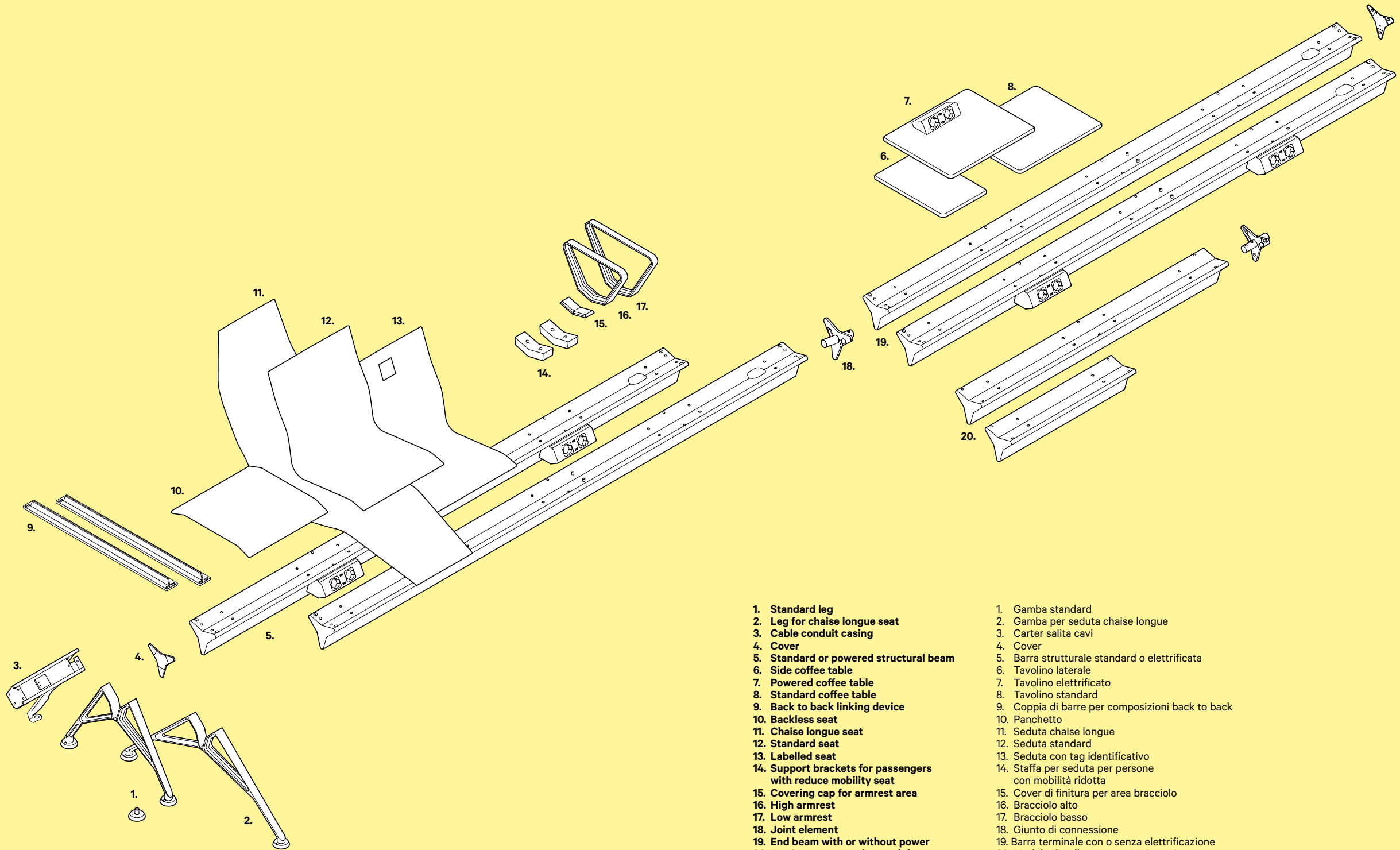

1. Standard leg
2. Leg for chaise longue seat
3. Cable conduit casing
4. Cover
5. Standard or powered structural beam
6. Side coffee table
7. Powered coffee table
8. Standard coffee table
9. Back to back linking device
10. Backless seat
11. Chaise longue seat
12. Standard seat
13. Labeled seat
14. Support brackets for passengers with reduce mobility seat
15. Covering cap for armrest area
16. High armrest
17. Low armrest
18. Joint element
19. End beam with or without power
20. 1 or 2 seat connection modules

1. Gamba standard
2. Gamba per seduta chaise longue
3. Carter salita cavi
4. Cover
5. Barra strutturale standard o elettrificata
6. Tavolino laterale
7. Tavolino elettrificato
8. Tavolino standard
9. Coppia di barre per composizioni back to back
10. Panchetto
11. Seduta chaise longue
12. Seduta standard
13. Seduta con tag identificativo
14. Staffa per seduta per persone con mobilità ridotta
15. Cover di finitura per area bracciolo
16. Bracciolo alto
17. Bracciolo basso
18. Giunto di connessione
19. Barra terminale con o senza elettrificazione
20. Modulo di collegamento 1 o 2 posti

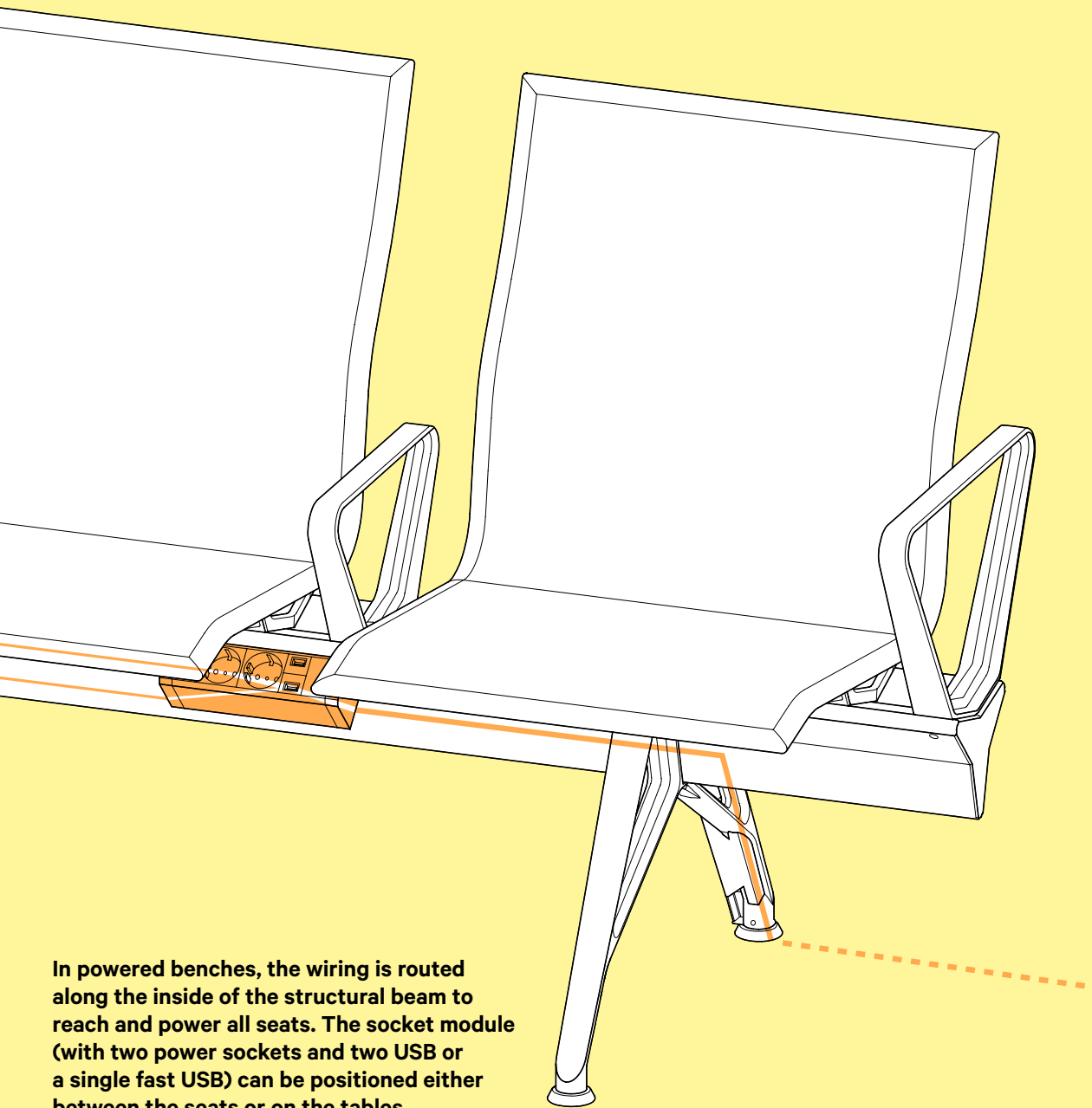

In powered benches, the wiring is routed along the inside of the structural beam to reach and power all seats. The socket module (with two power sockets and two USB or a single fast USB) can be positioned either between the seats or on the tables.

The cable routing along the leg down to the ground is concealed by the protective casing.

Nella panca predisposta per elettrificazione, il cablaggio scorre all'interno della barra strutturale così da raggiungere e servire tutte le sedute. Il modulo prese (a due prese corrente e due uscite USB o una fast USB) può essere posizionato sia tra le scocche che sui tavolini. Lo scorrimento del cavo lungo la gamba, fino a terra, è nascosto dal carter di protezione.







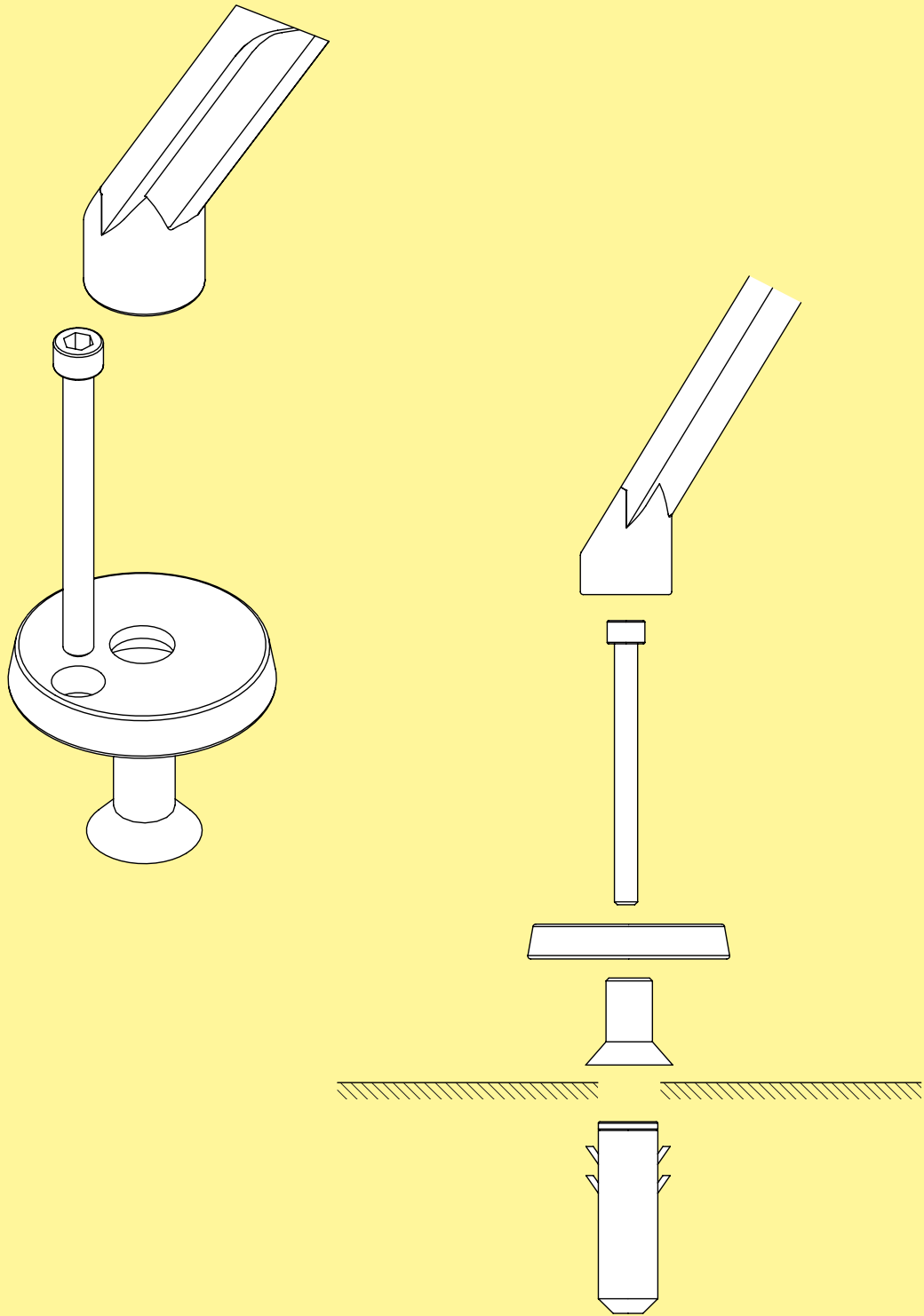





RS

Design:
SNCF Agence des Gares & Jean-Marie Duthilleul
 1998

A modular system of individual seats which can be combined together either on a fixed base (column) or on a mobile base, designed to offer a vast range of configurations to satisfy any design requirements. The one or two beams structure welcomes from 2 to 5 seats, which are available in aluminium, wood, leather, self-skinning polyurethane, upholstered in fabric, or formed metal sheet. The RS series is made with aluminium castings and extrusions, treated for excellent robustness and strength, and is suited to installation both indoors and outdoors.

Un sistema modulare di sedute individuali aggregabili e componibili, con la possibilità di montare sia basi fisse (a colonna) che mobili, concepito per offrire la massima flessibilità di configurazione in base alle esigenze progettuali. Sulla stessa struttura, a una o due barre, possono essere montate da 2 a 5 scocche disponibili in alluminio, legno, cuoio, autopellante, rivestite in tessuto o in lamiera stampata. La serie RS è realizzata in fusione e estrusione di alluminio sottoposta a trattamenti che rendono il sistema robusto, resistente e adatto ad ambienti interni ed esterni.



Along with the bench version with separate seats, the structure can assemble backless seats, fitted with armrests (on request), benches with wooden slats treated for outdoor usage, and standing rests for high passenger turnover areas. Tables and armrests can be freely assembled along the modular beam frame: the tables are available in a variety of finishes or bespoke on client's request, while the armrests are made in cast aluminium, painted or polished on the outside. The modular nature of the RS system means it can be easily modified or upgraded even after the initial installation, and it is simple to manoeuvre and reinstale.

Oltre alla versione panca con scocca individuale, la declinazione offre la possibilità di montare sulla stessa struttura panchetti senza schienale dotati di braccioli a richiesta, panche a doghe in legno trattate per gli esterni o soluzioni di "seduta in piedi" utilizzate nelle aree di sosta più breve. Tavolini e braccioli sono posizionabili liberamente sulla barra modulare: i tavolini sono disponibili in varie finiture o realizzabili su specifiche del cliente, mentre i braccioli sono realizzati in fusione di alluminio verniciato e lucidato a specchio nella parte esterna. Le componenti modulari di RS consentono di modificare o integrare il layout anche in tempi successivi alla prima installazione, semplificando la gestione e il reintegro del prodotto.







Aluminium backrest seat with armrest and mobile base
 Panca in alluminio con braccioli e base mobile

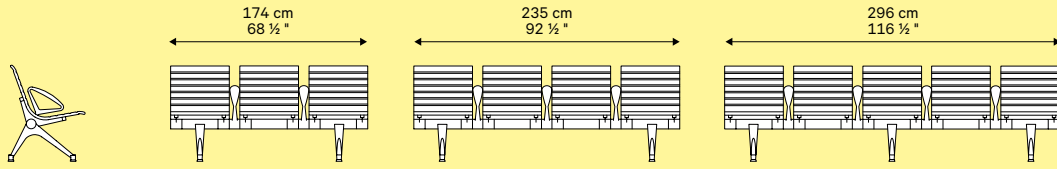

Leather seat with table and fixed base
 Panca in cuoio e tavolino con base fissa

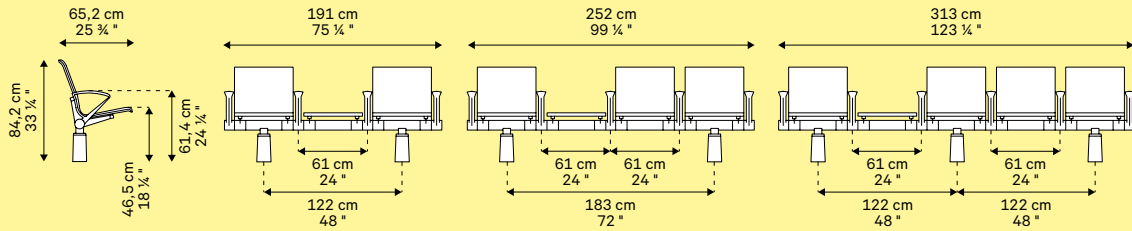

Backless seat with armrest
 Panchetto con braccioli

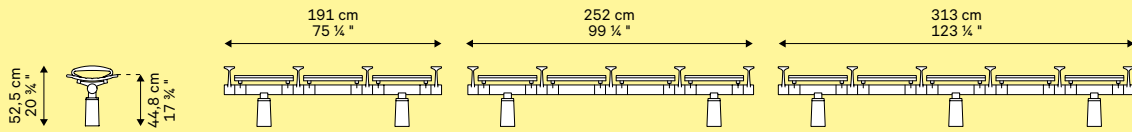

High seat
 Seduta in piedi

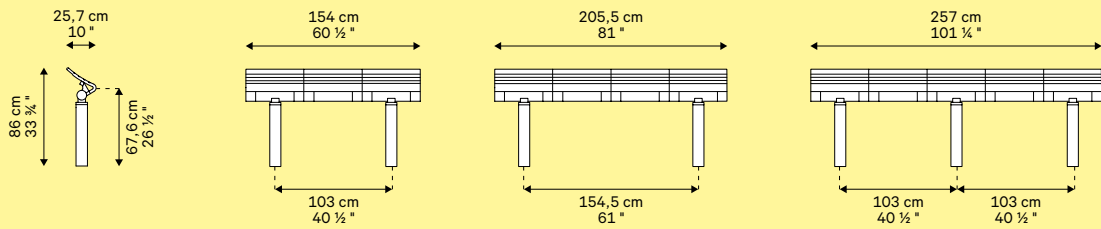

Exploded view of all RS seating system elements.
Esploso dei componenti del sistema RS.

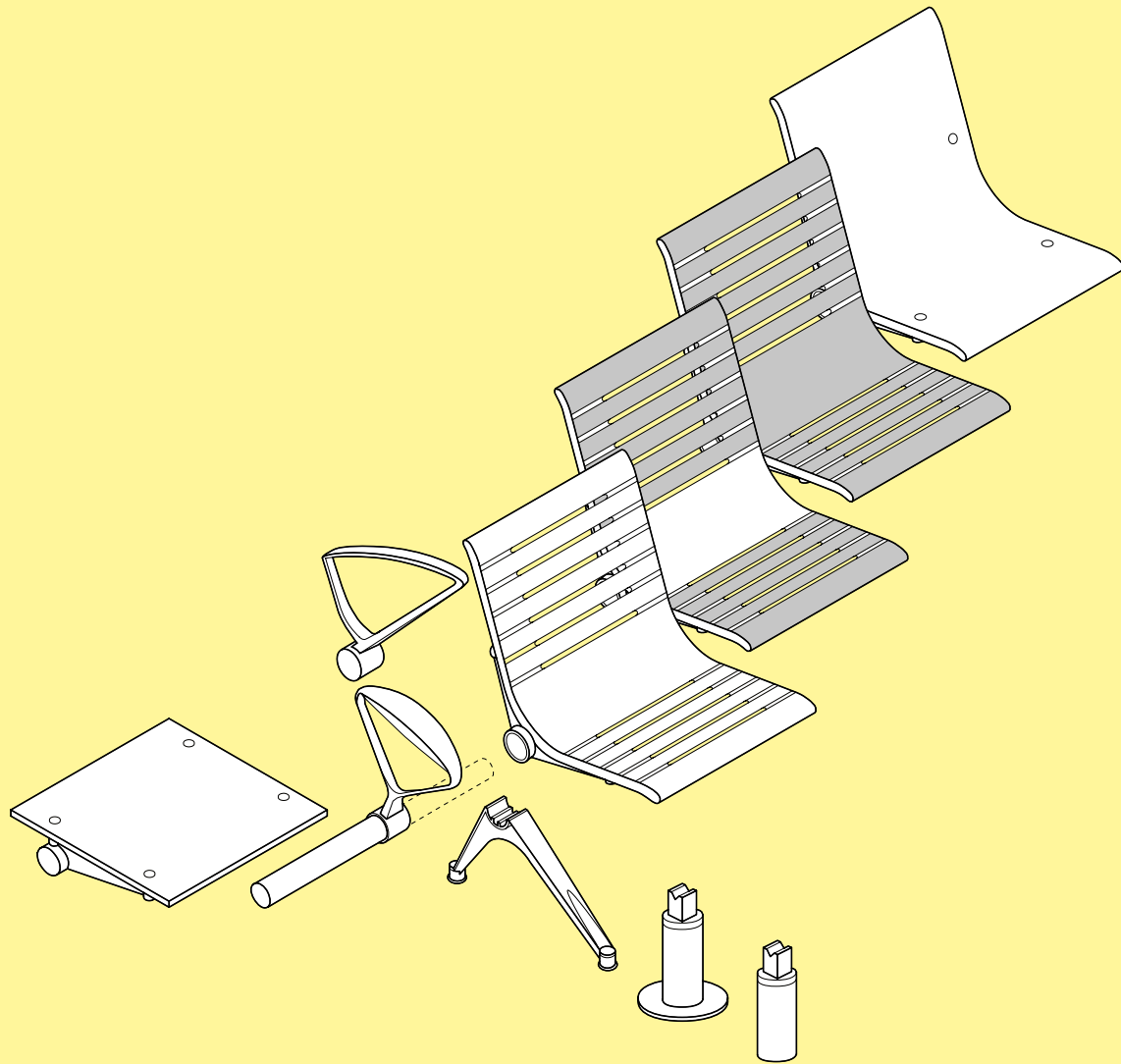

Schiphol Airport, Amsterdam (Netherlands)



23.000+
seats





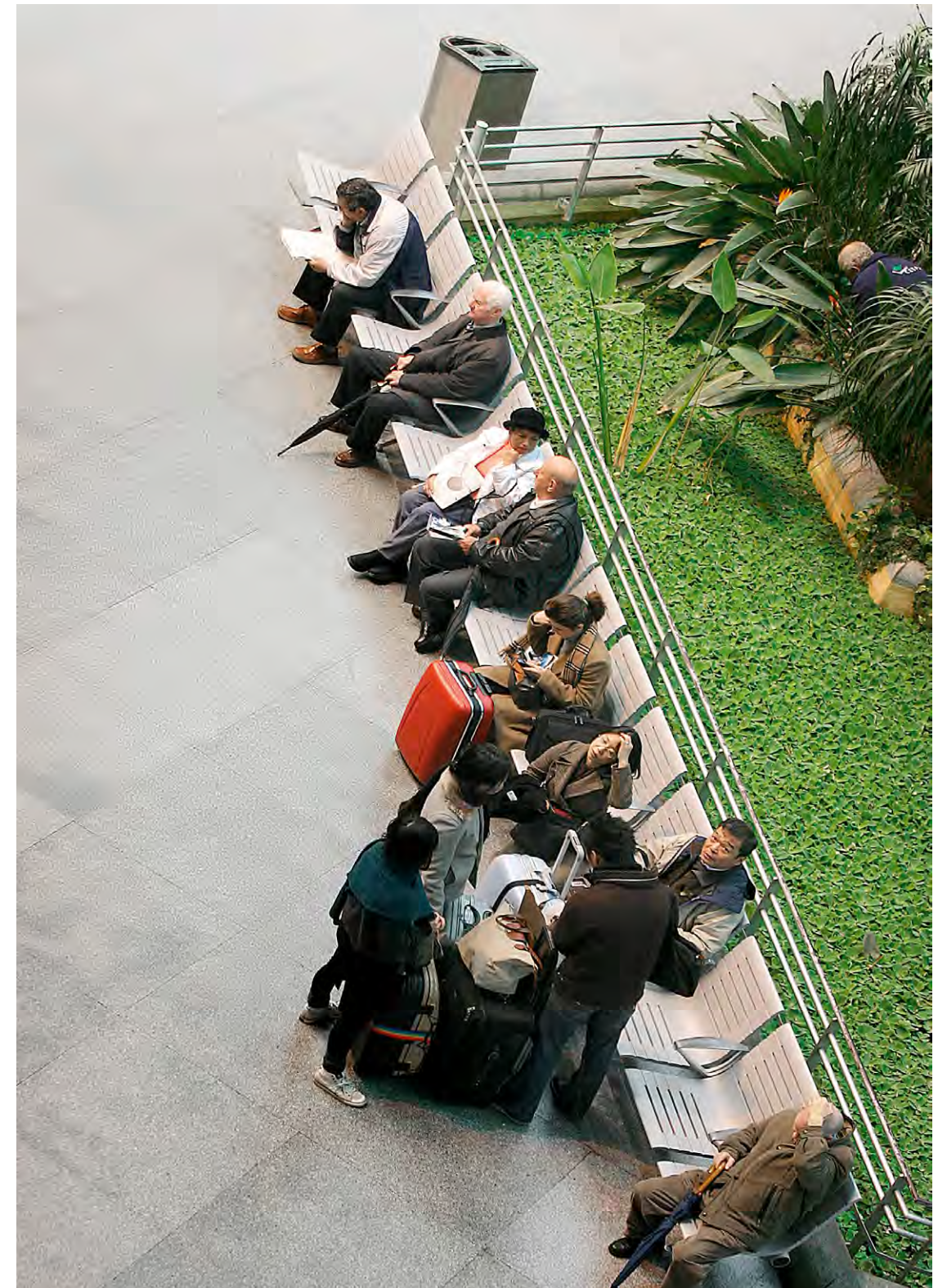



RS2

Design:
SNCF Agence des Gares & Jean-Marie Duthilleul
 2012

RS2 was created as a development of RS to permit the functionality required by the many electronic devices that passengers carry with them, offering electrical wiring and USB solutions built into the structure. Accessories like lamps, stools and free-standing tables, even with electric power sockets, complete the product range. RS2, ideal for both indoors and outdoors, becomes a fully fledged extension of the office, in answer to the increasing demand for waiting areas in which passengers can also work. Self-skinning polyurethane gives a highly pleasing effect and is also very robust. The ergonomic seat and backrest with lumbar support help the body assume a correct posture and ensure comfort even during long waits. The depth and height of the seats are designed to assist users with reduced mobility.

RS2 nasce dall'evoluzione di RS per accogliere la funzionalità richiesta dai molteplici strumenti elettronici che il passeggero porta con sé offrendo soluzioni di cablaggio elettrico e USB integrato alla struttura. Accessori quali lampade, sgabelli, tavoli free-standing elettrificabili completano la gamma di prodotto. RS2, adatta sia ad ambienti interni che esterni, diventa una vera e propria estensione dell'ufficio, in risposta alle esigenze di aree di attesa che spesso si trasformano in luoghi di lavoro temporaneo. L'uso dell'autopellante, una materia poliuretanicca, dona gradevolezza estetica e grande resistenza. La forma ergonomica del sedile e lo schienale con sostegno lombare assecondando la forma del corpo assicurando il comfort anche nelle attese più lunghe. La profondità e l'altezza agevolano nell'utilizzo anche le persone a ridotta mobilità.





469 cities*

* Total amount completed during the SNCF supply to this date. Complessive realizzate durante il progetto SNCF fino ad oggi.

Over 60.000 seats*



* Total amount completed during the SNCF supply to this date.
Complessive realizzate durante il progetto SNCF fino ad oggi.

1.049
railway
stations*



* Total amount completed during the SNCF supply to this date.
 Complessive realizzate durante il progetto SNCF fino ad oggi.

Aluminium backrest seat with Y base
Panca in alluminio con base a Y

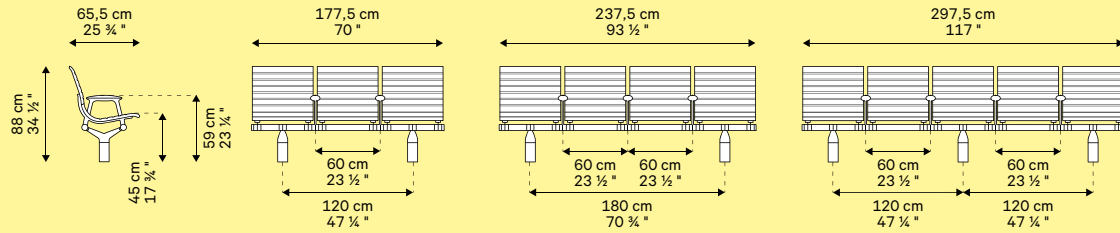

Aluminium backrest seat with X base
Panca in alluminio con base a X

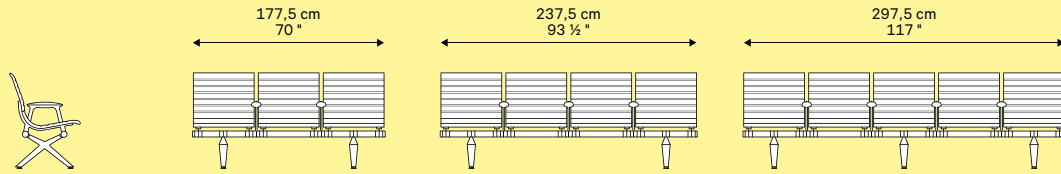

Aluminium backless seat with column base
Panchetto in alluminio con base a colonna

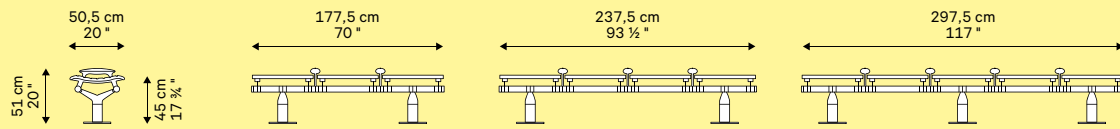

Self-skinning polyurethane seat
Panca in autopellante

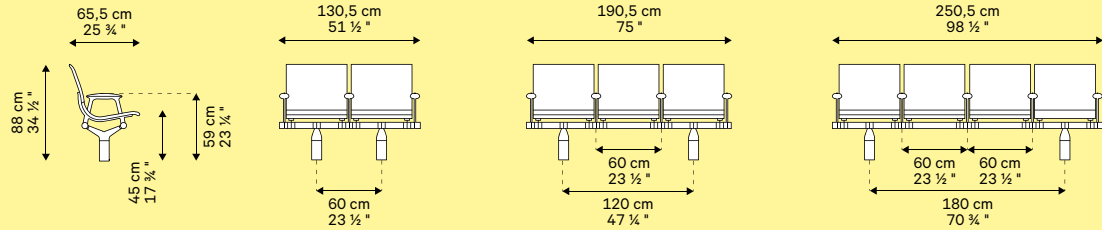

High seat
Seduta in piedi

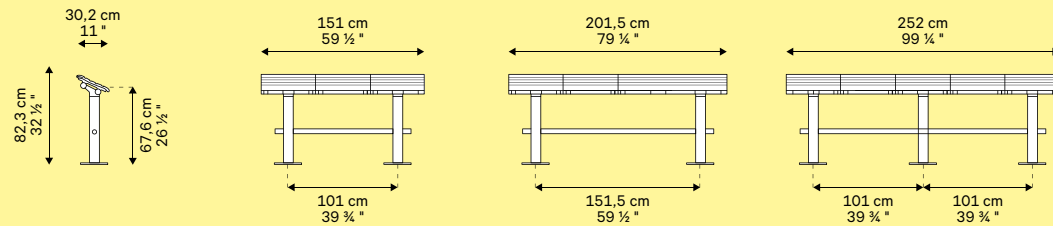

Exploded view of all RS2 seating system elements.
Esploso dei componenti del sistema RS2.

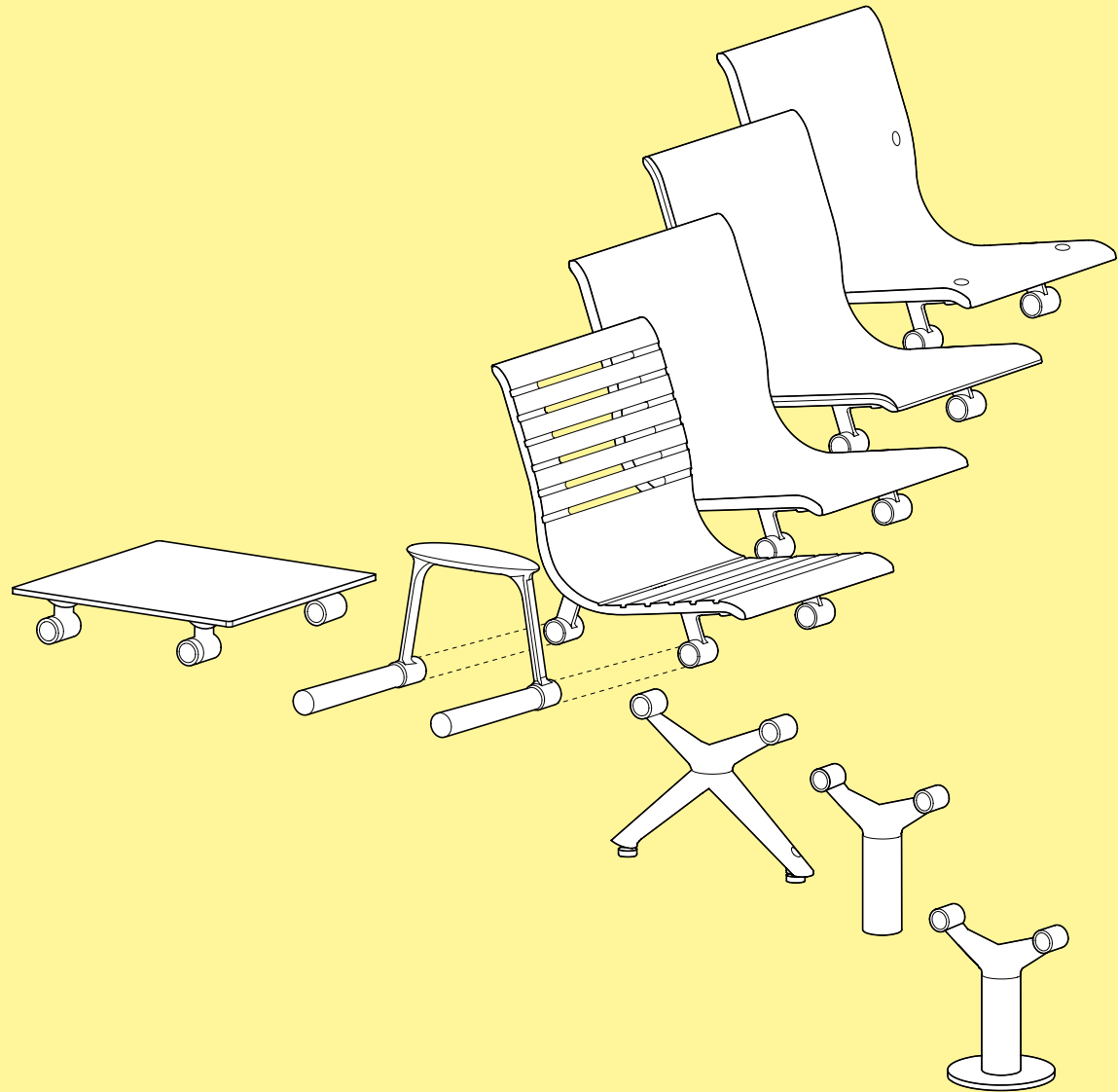

Gare de Lorient, Lorient (France)



Wire management scheme in the RS2 seating system.
Schema di gestione dell'elettrificazione nel sistema RS2.

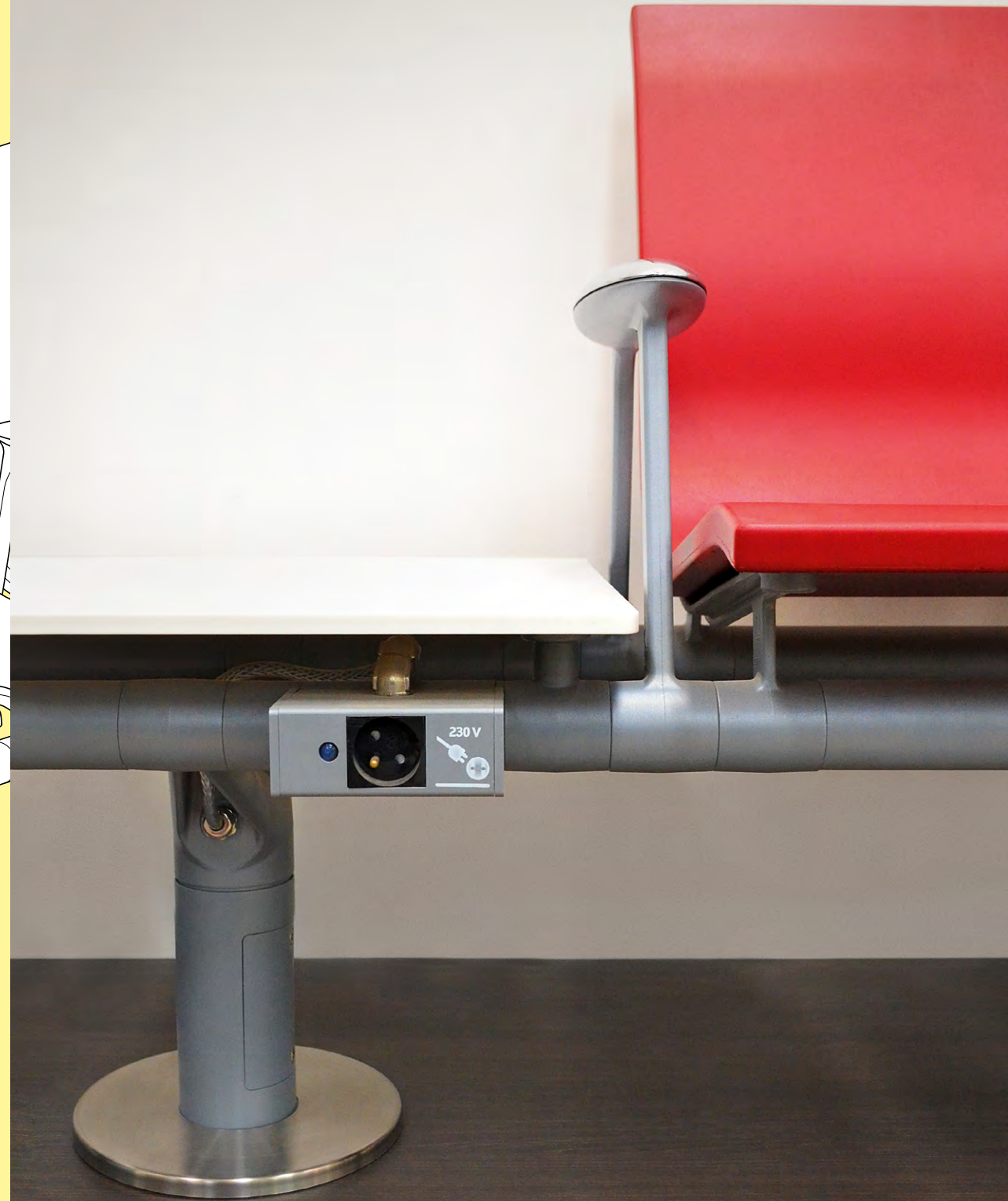
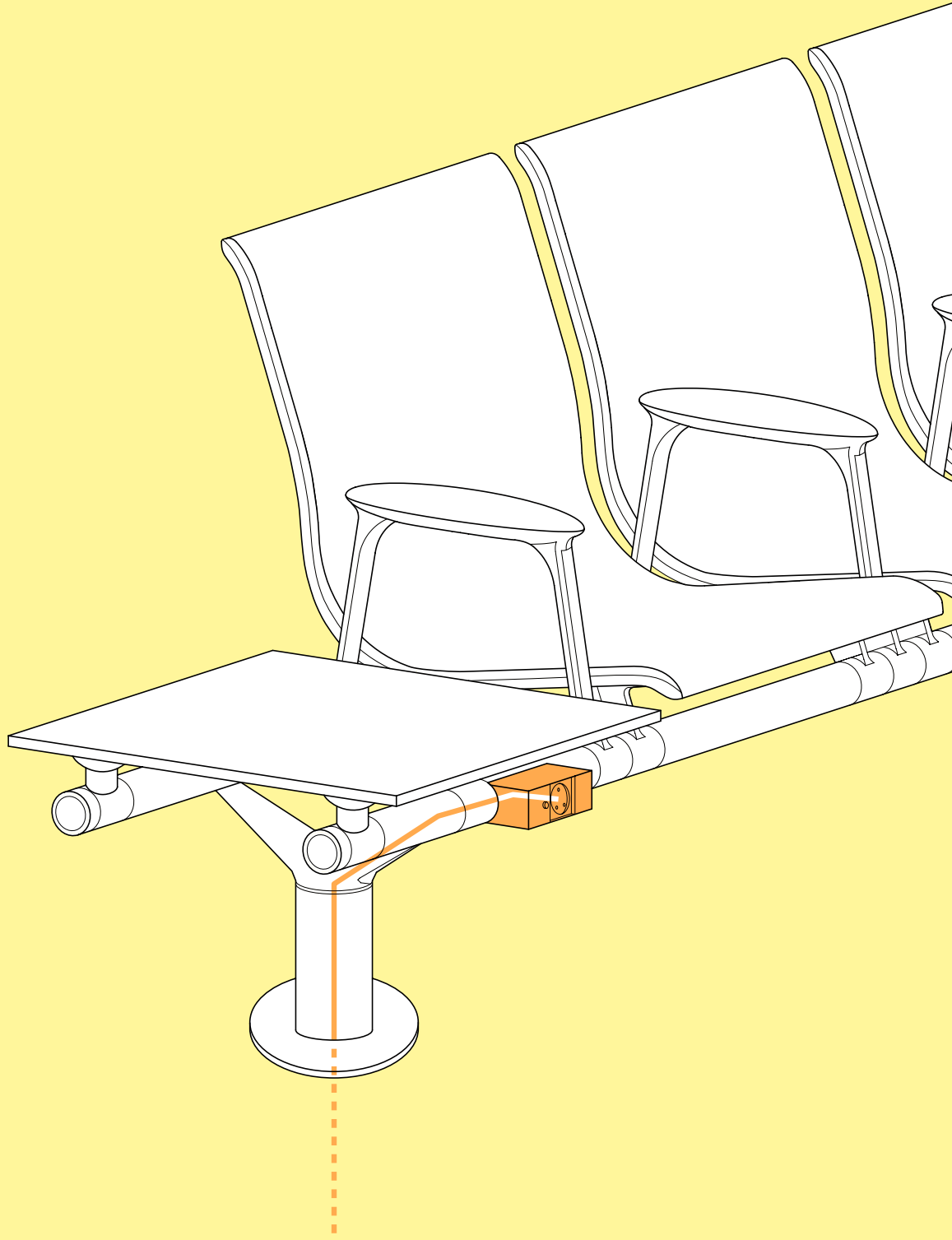



Airports

Aeroporti

Agadir-Al Massira, Agadir, Morocco
CMN Mohammed V International,
 Casablanca, Morocco
DIA Hamad International, Doha, Qatar
El Prat, Barcelona, Spain
EWR Newark International, New York, USA
FCO Leonardo da Vinci Fiumicino International,
 Rome, Italy
Fontanarossa, Catania, Italy
LIN Linate (SEA), Milan, Italy
Malaga, Spain
Manila International, Philippines
MEL Tullamarine, Melbourne, Australia
MXP Malpensa International (SEA), Milan, Italy
ONDA Network, Morocco
Rabat-Salé, Rabat, Morocco
RAI Nelson Mandela Praia Capoverde,
 Praia, Capo Verde
SCH Schiphol International,
 Amsterdam, The Netherlands
SIN Changi, Singapore
STN Stansted International, London, UK
Tangeri-Ibn Battuta, Tangeri, Morocco
VCE Marco Polo (SAVE), Venice, Italy

Railways

Ferrovie

Amtrak Washington D.C., USA
ArRiyadh New Mobility Consortium (ANM)
 Line 3-4-5-6, Riyadh, Saudi Arabia
Irish Rail Heuston Station, Dublin, Ireland
Lusail LRT Metro Project Doha, Qatar
Network Rail, UK
OBB - Deutche National Raiway Network,
 Austria
RENFE - Railway Network, Spain
RFI Grandi Stazioni - National Railway, Italy
SNCB - National Railway Network, Belgium
SNCF - National Railway Network, France
Staten Island Ferry Terminal, New York, USA
Trenord, Italy
Underground Station, Duisburg, Germany

Certificates Certificazioni

Aeris

ANSI BIFMA X5.4:2012	Safety, durability and structural test Test su sicurezza, resistenza e durabilità
UNI EN 16139:2013	Mechanical resistance and durability test Test di resistenza meccanica, sicurezza e durabilità
EN 1021-1:2014	Fire Test Test di accendibilità
EN 1021-2:2006	Fire Test Test di accendibilità
BS 5852:2006 Crib 5	Fire Test Test di accendibilità
EN 12720:2009 + A1:2013	Resistance to liquid test Test di resistenza ai liquidi

RS

EN 12727	Seat, backrest and armrests bearing test Test di carico su sedile, schienale, braccioli
NF D 61 071	Armrests bearing test Test di carico sui braccioli
EN 12727	Seat, backrest and armrests bearing test Test di carico su sedile, schienale, braccioli
ANSI BIFMA X5.4	Stability and seat, backrest and armrests bearing test Test di stabilità e carico su sedile, schienale, braccioli
ANSI BIFMA X5.4	Stability and seat, backrest and armrests bearing test Test di stabilità e carico su sedile, schienale, braccioli
EN 1022	Seat stability test Sedute - Determinazione della stabilità
EN 1728	Stability and seat, backrest and armrests bearing test Test di stabilità e carico su sedile, schienale, braccioli
Type approval 1 IM Omologazione 1 IM	Fire reaction test Test di reazione al fuoco

RS2

EN 12727:2000	Structural strength and durability test Test di resistenza strutturale e durabilità
NF D 60-013	Fire resistance test Test di resistenza al fuoco

Frequent travelling turns the interiors into changing and hybrid spaces. They offer a new panorama of small, comfortable, multifunctional and connected lounges which turn waiting time into an opportunity to relax, meet other people, study and work.

I viaggi frequenti rendono oggi gli spazi interni mutevoli e ibridi. Un panorama nuovo di piccoli salotti confortevoli, multifunzionali e connessi che trasformano i tempi di attesa in pause di relax, in opportunità di incontro e conversazione, in momenti di studio o lavoro.

Linea 76

Pax 86

Aura 94

Laetitia 102

Archipelago 110

Pons 118

Todo Modo 124

P32 132

P40, D70 138

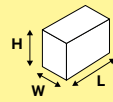
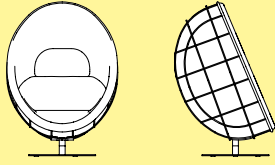
**Pax** pag. 86

Cocoon armchair
Poltrona cocoon
L 65 cm, W 97 cm, H 148 cm
L 25 ½", W 34 ¾", H 58 ½"

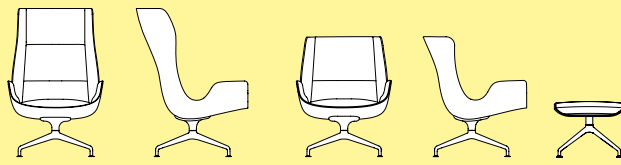
Aura pag. 94

Armchair with high backrest
Poltrona con schienale alto
L 74,7 cm, W 87,8 cm, H 116,5 cm
L 29 ½", W 34 ¾", H 46"

Armchair with low backrest
Poltrona con schienale basso
L 74,7 cm, W 87,8 cm, H 94 cm
L 29 ½", W 34 ¾", H 37"

Pouf
L 56 cm, W 53 cm, H 45 cm
L 22", W 21", H 18"

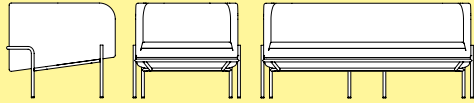
Laetitia pag. 102

Armchair
Poltrona
L 78 cm, W 79 cm, H 69 cm
L 30 ¾", W 31", H 27"

2-seater sofa
Divano 2 posti
L 150 cm, W 79 cm, H 69 cm
L 59", W 31", H 27"

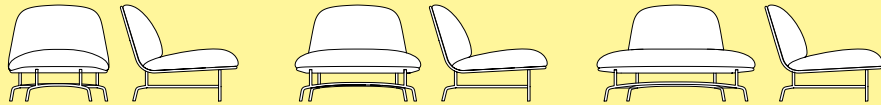
Archipelago pag. 110

Small armchair
Poltrona piccola
L 76 cm, W 84 cm, H 76 cm
L 30", W 33", H 30"

Medium armchair
Poltrona media
L 95 cm, W 86 cm, H 76 cm
L 37 ½", W 33 ¾", H 30"

Large armchair
Poltrona grande
L 121 cm, W 86 cm, H 76 cm
L 47 ¾", W 33 ¾", H 30"

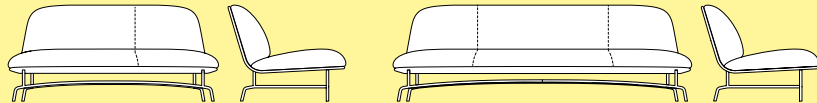

2-seater sofa, stitching on left or right
Divano 2 posti, cucitura lato destro o sinistro
L 162 cm, W 87,5 cm, H 76 cm
L 63 ¾", W 34 ½", H 30"

3-seater sofa
Divano 3 posti
L 230 cm, W 88,5 cm, H 76 cm
L 90 ½", W 34 ¾", H 30"

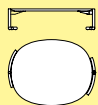

Low coffee table, first component of a system, either free-standing or with attachment to the structure of armchairs / sofas
Tavolino basso per sistema di tavolini free-standing o con aggancio alla struttura di poltrone / divani
L 61 / 75 cm, W 49 / 61 cm, H 19 cm
L 24 / 29 ½", W 19 ½ / 24", H 7 ½"

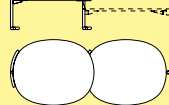

Medium coffee table
Tavolino medio
L 61 / 75 cm, W 49 / 61 cm, H 32 cm
L 24 / 29 ½", W 19 ½ / 24", H 12 ¾"

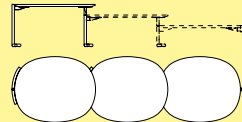

High coffee table
Tavolino alto
L 61 / 75 cm, W 49 / 61 cm, H 45 cm
L 24 / 29 ½", W 19 ½ / 24", H 17 ¾"

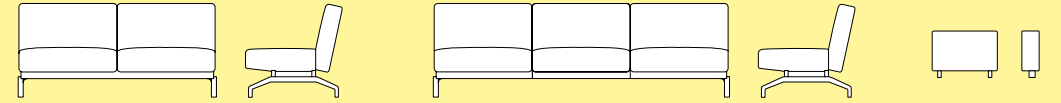
Pons pag. 118

Low-back 2-seater sofa without armrests
Divano 2 posti schienale basso senza braccioli
L 160 cm, W 81 cm, H 74 cm
L 63", W 32", H 29"

Low-back 3-seater sofa without armrests
Divano 3 posti schienale basso senza braccioli
L 240 cm, W 81 cm, H 74 cm
L 94 ½", W 32", H 29"

Armrest
Bracciolo
L 11 cm, W 62 cm, H 34 cm
L 4 ¼", W 24", H 13 ½"

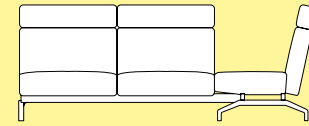

2+2-seater sofa with high backrest
Divano 2+2 posti con schienale alto
L 251 cm, W 251 cm, H 98 cm
L 99", W 99", H 38 ½"

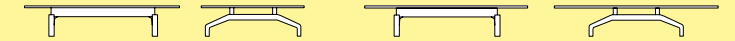

Rectangular coffee table
Tavolino rettangolare
L 120×80 cm / 160×80 cm, H 25 cm
L 47 ¾×31 ½" / 63×31 ½", H 10"

Round coffee table
Tavolino rotondo
Ø 130 cm, H 25 cm
Ø 51 ¼", H 10"

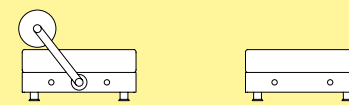
Todo Modo pag. 124

Seat with backrest
Seduta con schienale
L 90 cm, W 87 cm, H 71 cm
L 35 ½", W 34 ¼", H 28"

Seat without backrest
Seduta senza schienale
L 90 cm, W 87 cm, H 41,5 cm
L 35 ½", W 34 ¼", H 16 ½"

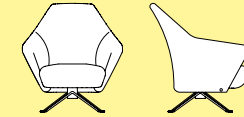
P32 pag. 132

Relaxing armchair
Poltrona relax
L 85 cm, W 80 cm, H 83 cm
L 33 ¾", W 31 ½", H 32 ¾"

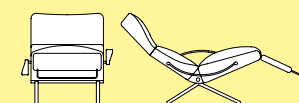
P40 pag. 138

Relaxing armchair
Poltrona relax
L 72 cm, W 80-150 cm, H 70-90 cm,
L 28 ½", W 31 ½"-59", H 27 ½"-35 ½"

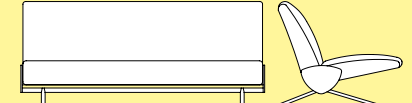
D70 pag. 139

Sofa with mobile wings
Divano ad ali mobili
L 195 cm, W 90-115 cm, H 85 cm
L 76 ¾", W 35 ½"-45 ½", H 33 ½"

Design:
Zanon Architetti Associati, Centro Progetti Tecno
 2018

A modular, continually reconfigurable micro-architectural system, designed to define and organise spaces. The result is a flexible structure that can be customised to suit the layout of spaces and specific needs: a simple and functional solution that can characterise interior design projects, from work environment to educational spaces. Available in a wide range of materials and finishes, the structures can be integrated with accessories including cupboards, drawers, shelves, blackboards and seats.

Sistema micro-architettonico, modulare e continuamente riconfigurabile, studiato per definire e organizzare gli spazi. Il risultato è una struttura flessibile e personalizzabile in relazione alla disposizione degli ambienti e alle necessità di utilizzo: una soluzione semplice e funzionale che può caratterizzare molteplici progetti di interior, dai luoghi di lavoro fino ad ambienti educacional. In una grande varietà di materiali e finiture, le strutture si integrano con accessori come ante, cassetti, ripiani, lavagne e sedute.



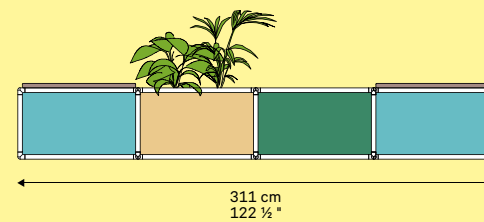
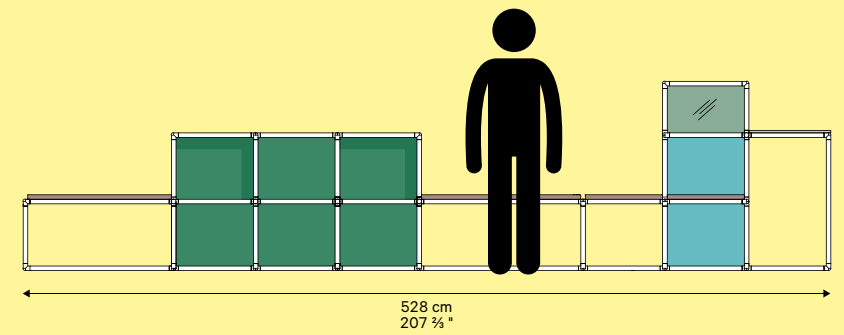
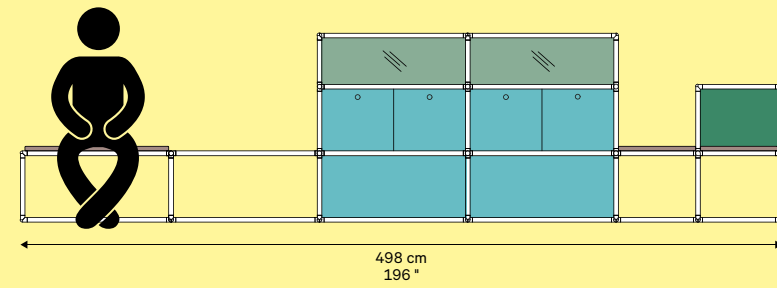
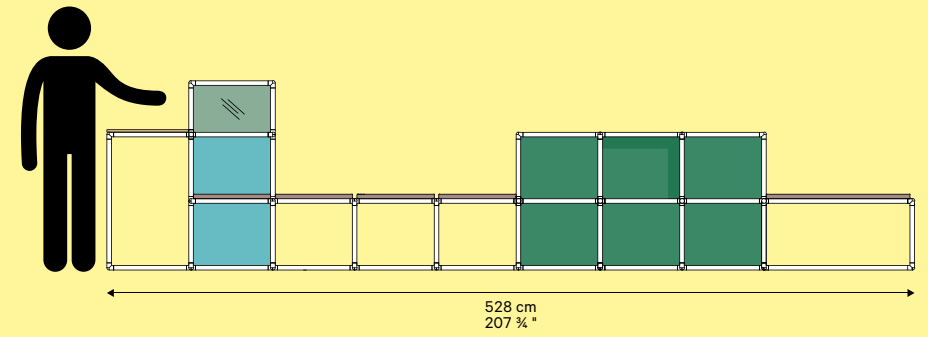
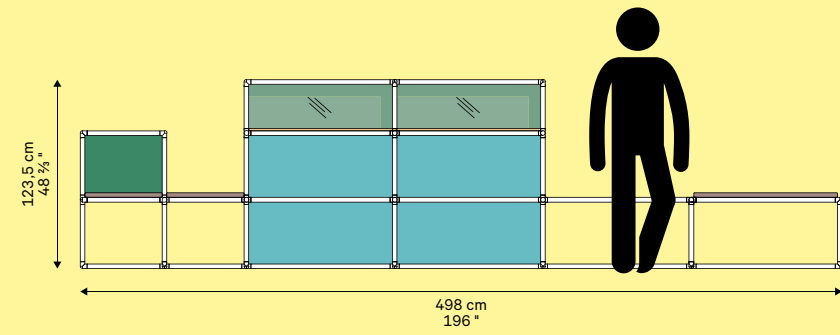
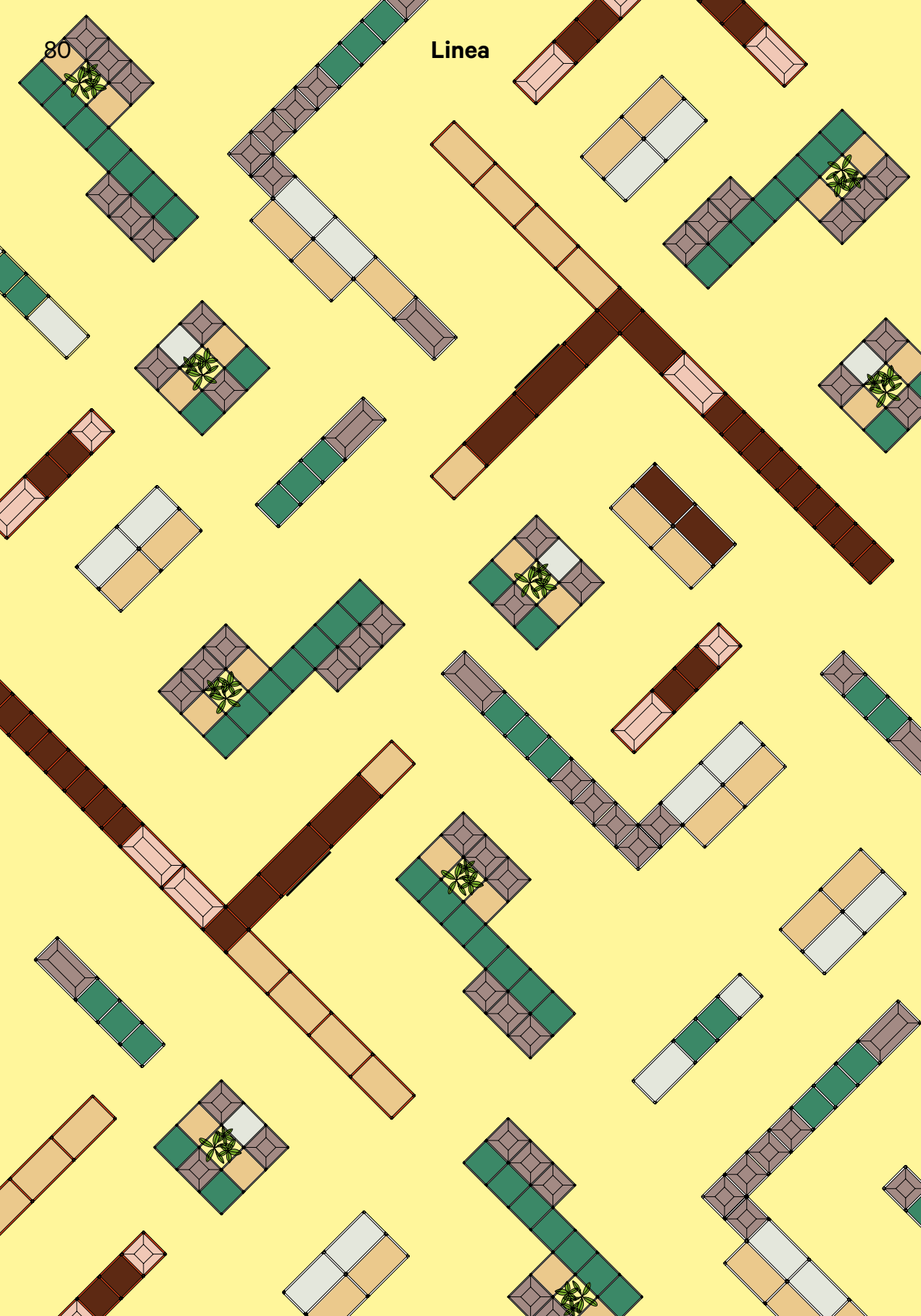

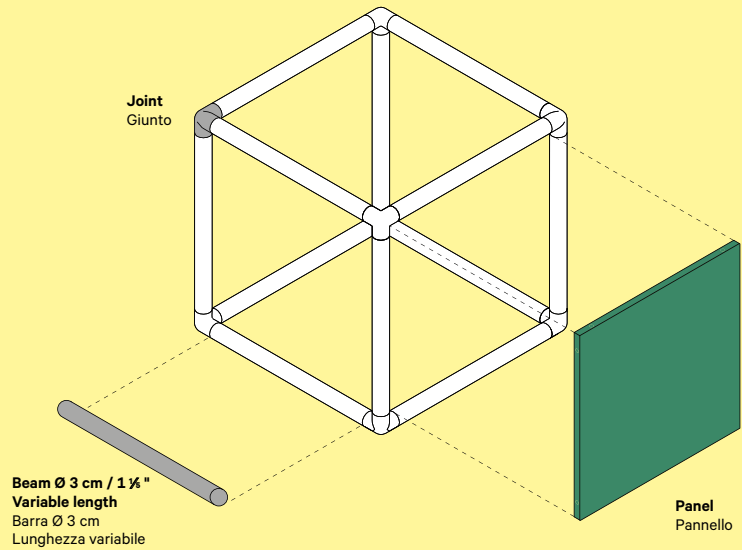

Beam Ø 3 cm / 1 1/4"
Variable length
Barra Ø 3 cm
Lunghezza variabile

Panel
Pannello

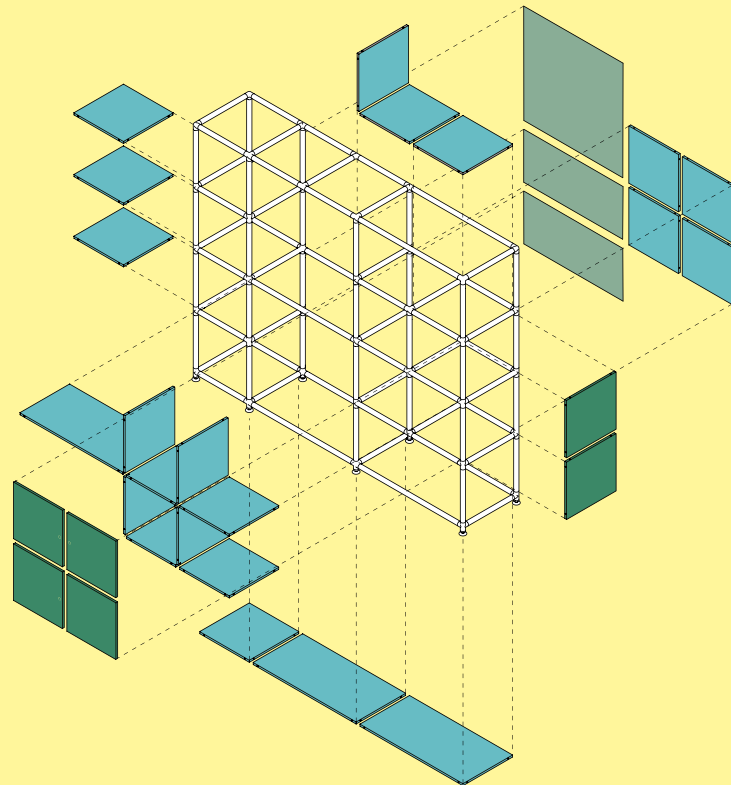

Linea

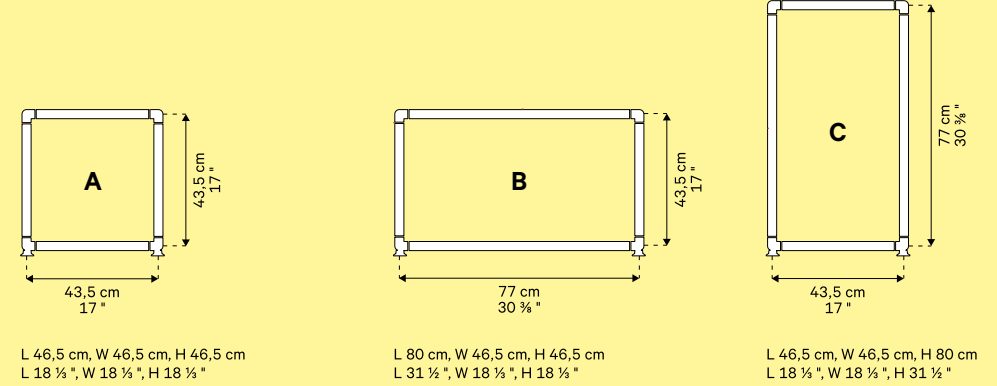

L 46,5 cm, W 46,5 cm, H 46,5 cm
L 18 1/2", W 18 1/2", H 18 1/2"

L 80 cm, W 46,5 cm, H 46,5 cm
L 31 1/2", W 18 1/2", H 18 1/2"

L 46,5 cm, W 46,5 cm, H 80 cm
L 18 1/2", W 18 1/2", H 31 1/2"

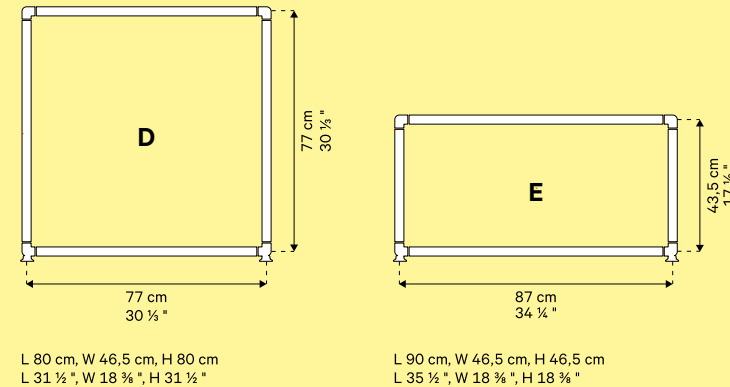

L 80 cm, W 46,5 cm, H 80 cm
L 31 1/2", W 18 3/4", H 31 1/2"

L 90 cm, W 46,5 cm, H 46,5 cm
L 35 1/2", W 18 1/2", H 18 1/2"

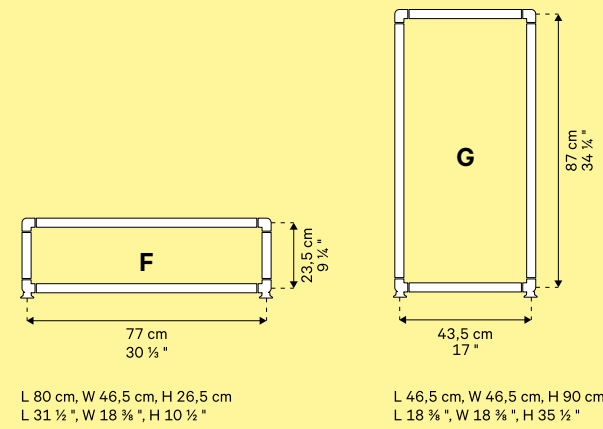

L 80 cm, W 46,5 cm, H 26,5 cm
L 31 1/2", W 18 3/4", H 10 1/2"

L 46,5 cm, W 46,5 cm, H 90 cm
L 18 1/2", W 18 3/4", H 35 1/2"

- The total standard depth (W) is 46,5 cm - 18 3/4" or 56,5 cm - 22 1/4"
- Adjustable feet Ø 4,5 cm - 1 1/4", H 1,5 cm 3/5"
- Compartment with top-hinged or bottom-hinged flap door available for structures: B
- Compartment with low drawers or file drawer available for structures: A, B
- Compartment with door available for structures: A, C, G
- La profondità (W) totale standard è di 46,5 cm o 56,5 cm
- Piedini regolabili Ø 4,5 cm, H 1,5 cm
- Vano con ribaltina a salire o scendere disponibile per strutture: B
- Vano con 2 cassetti bassi o 1 classificatore disponibile per strutture: A, B
- Vano con anta disponibile per strutture: A, C, G





Pax

Design:
David Rockwell, Centro Progetti Tecno
 2021



The unconventional seat that delivers softness and privacy within open spaces. A room within a room: an individual area in which to isolate oneself, read, listen to music, make a phone call or relax. A flexible and adaptable product performs several functions depending on the context, ideal for work environments, public lounges, reception areas and lobbies.

Seduta anticonvenzionale, che racchiude morbidezza e privacy in spazi aperti. Una camera dentro una camera: una zona personale in cui isolarsi, leggere, ascoltare musica, telefonare o rilassarsi. Un prodotto flessibile e adattabile che assolve a più funzioni a seconda del contesto, ideale per ambienti work, lounge pubbliche, aree di accoglienza e lobby.



The cocoon effect, enveloping and cozy, is created by a metal tubular basketwork frame that encloses a soft, upholstered and sculpted foam shell. The curved shell provides a comfortable and calm atmosphere, creating micro-oases that offer shelter from outside noise within an intimate space.

L'effetto cocoon, avvolgente ed accogliente, è realizzato da una struttura a cestello in tubo metallico che racchiude il morbido guscio in schiuma, rivestito e scolpito. L'involucro curvo conferisce un'atmosfera comoda e calma, creando micro-oasi che isolano dai rumori esterni e riportano in una dimensione intima.

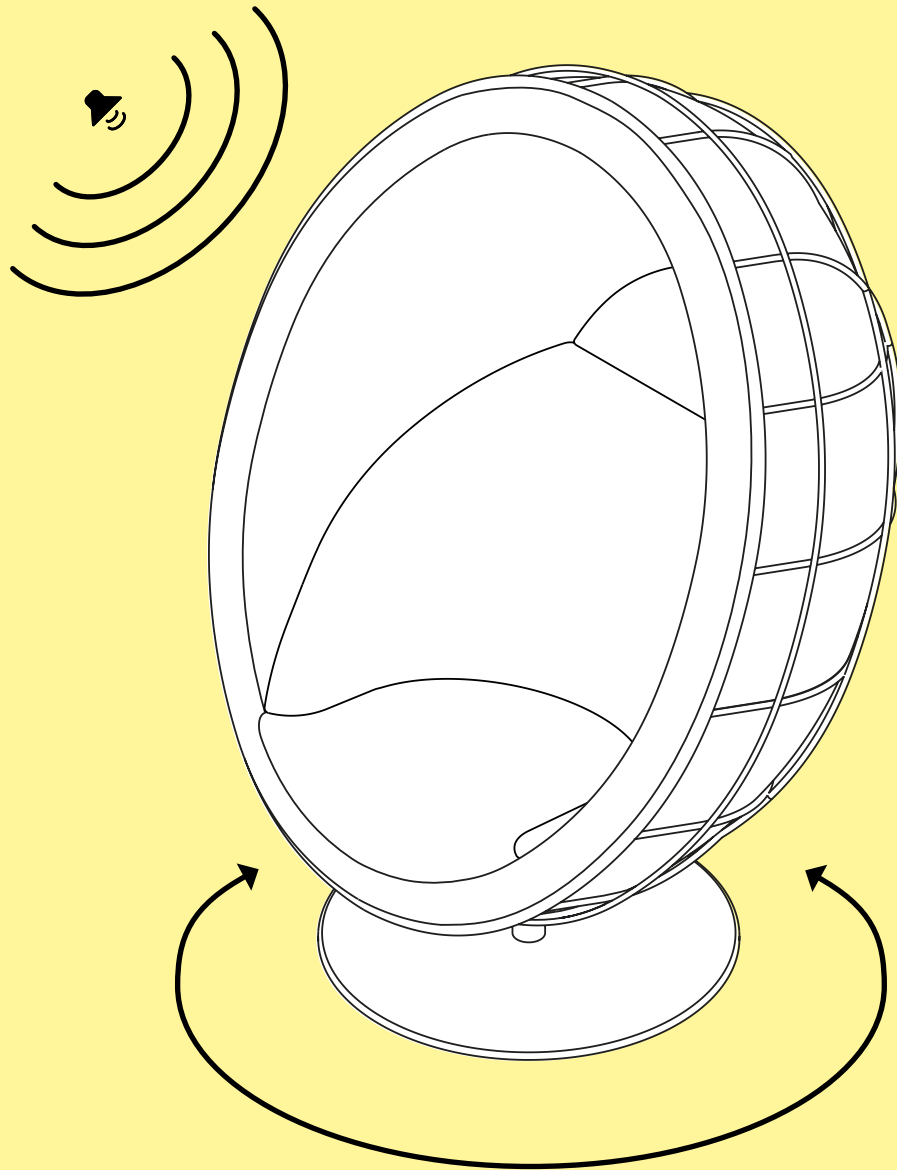

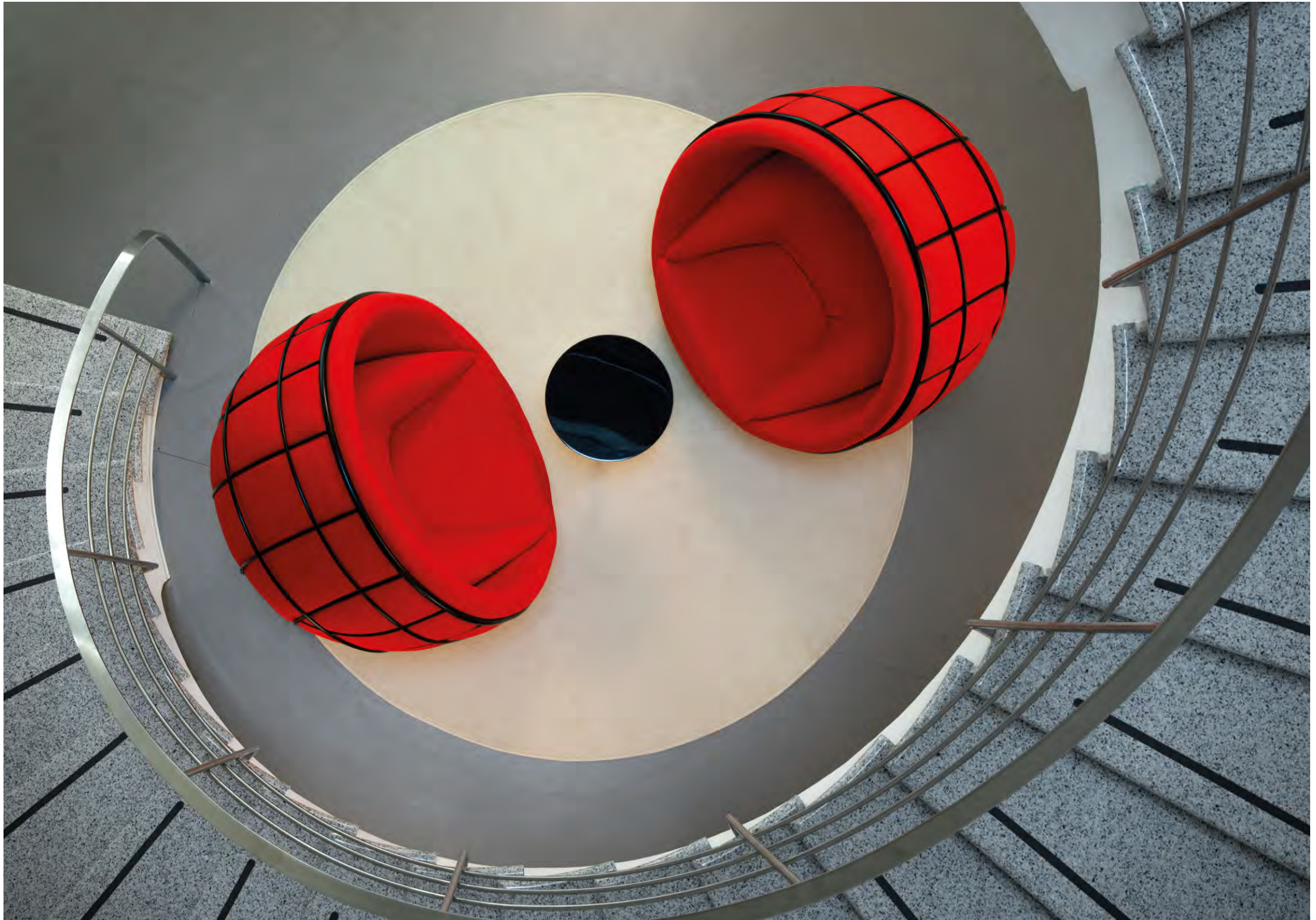

Aura

Design:
Rainlight, Centro Progetti Tecno
2018



A chair that favours thinking and meditation. In a modern-day society that is constantly connected and geared to sharing, the enveloping shape of the shell helps to create a private space: favouring a feeling of privacy and aiding concentration in co-working spaces, lounges, open-space offices and home-office environment, as well as in community and public areas.

Una seduta che favorisce il pensiero e la meditazione. In una realtà sempre connessa e orientata alla condivisione, la forma avvolgente della scocca contribuisce a creare un'area di privacy, suggerendo una sensazione di riservatezza e favorendo la concentrazione all'interno degli spazi co-working, le lounge, gli uffici open space, le situazioni home-office, così come nei luoghi collettivi e negli ambienti pubblici.





The chair welcomes its occupant with its carefully designed shape and ergonomic precision; the design expresses technical elegance and technologically advanced content in the choice of materials and production processes. The armchair, with painted die-cast aluminium base, comprises a mono-satin methacrylate monocoque shell. The large cushion within the seat back, structured in zones with differentiated bearing capacity, was developed to ensure the maintenance of optimum user ergonomics, for maximum comfort.

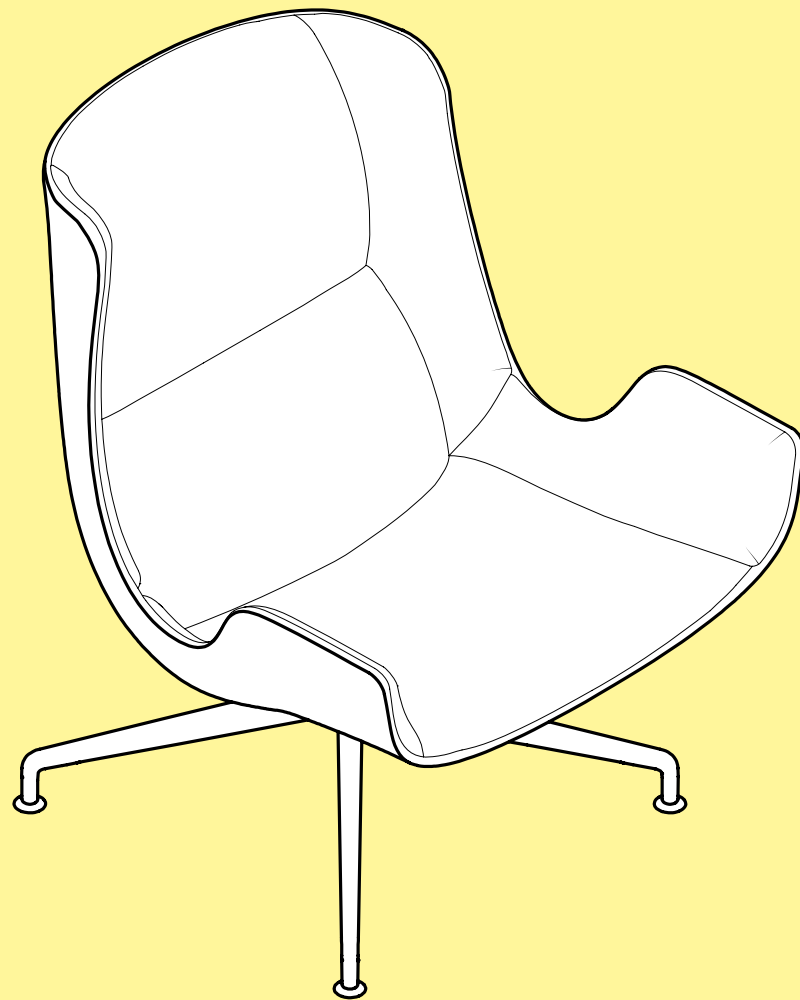

Lo studio delle forme e la precisione ergonomica rendono la seduta confortevole e accogliente; il progetto esprime l'eleganza tecnica e i contenuti tecnologicamente avanzati attraverso la scelta dei materiali e dei processi produttivi. La poltrona, con base in pressofusione di alluminio verniciato, è costituita da una monoscocca in metacrilato monosatinato. L'ampio cuscino interno di rivestimento, strutturato in zone a portanza differenziata, è studiato per garantire il mantenimento della corretta linea ergonomica favorendo il massimo comfort della persona.

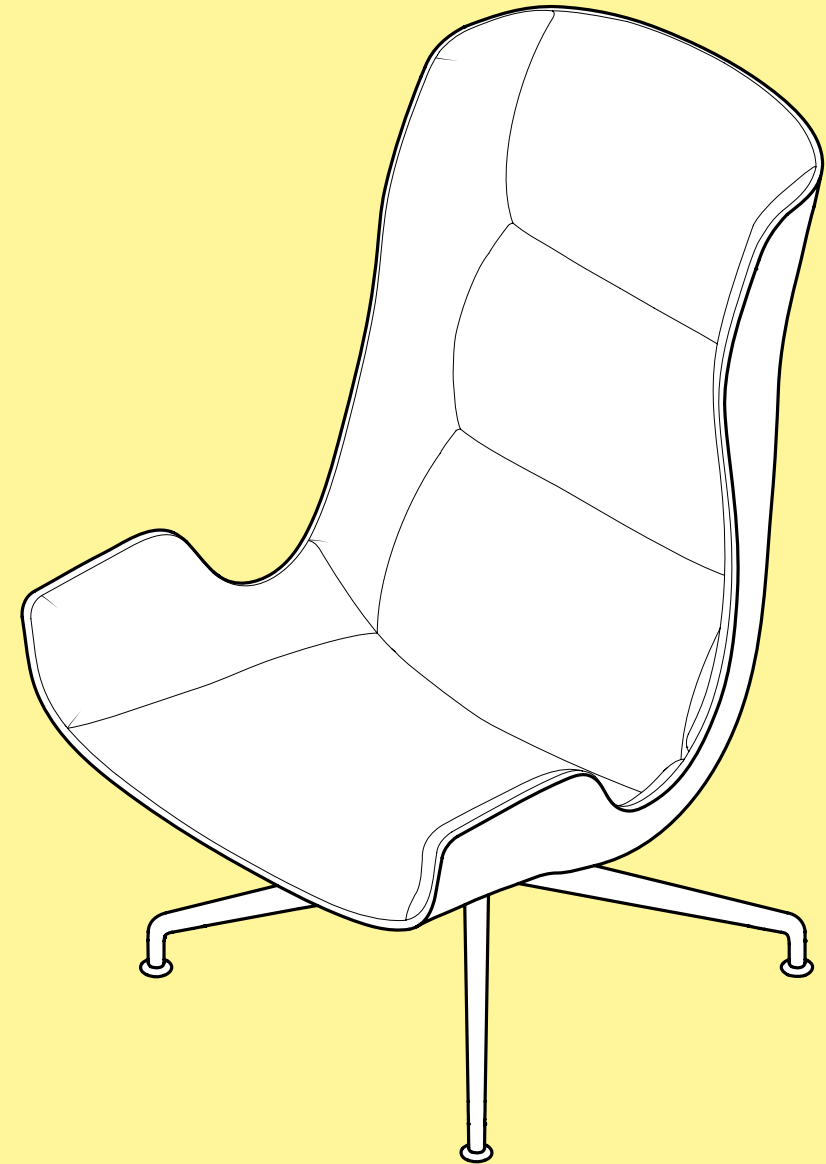



Design:
Fabio Fantolino
 2019

An armchair and a compact two seat sofa with an unusual horseshoe shape that encircles and protects its occupant. The comfortable padding of the seat, in shaped, variable density polyurethane, provides outstanding comfort in all positions, thanks to the continuity between the armrests and backrest which is a characteristic of the collection. The base is formed of a robust and yet visually lightweight steel tubing frame with the soft form of the seat that seems to float above it. The versatile seat is designed for lounges and waiting rooms, in both public and private areas, and is ideally suited for contract furniture suppliers.

Poltroncina e divano a due posti dalle proporzioni contenute e dall'inusuale forma a ferro di cavallo che avvolge e protegge. La comoda imbottitura della seduta, in poliuretano sagomato a densità differenziata, assicura un elevato comfort in tutti gli appoggi, grazie alla linea continua tra schienale e braccioli che caratterizza la collezione. La base è composta da una struttura resistente, dall'impatto visivo leggero, che crea un effetto sospeso del volume morbido della scocca. La seduta versatile è progettata per soluzioni lounge e di attesa, in spazi collettivi e privati e per le esigenze delle forniture contract.



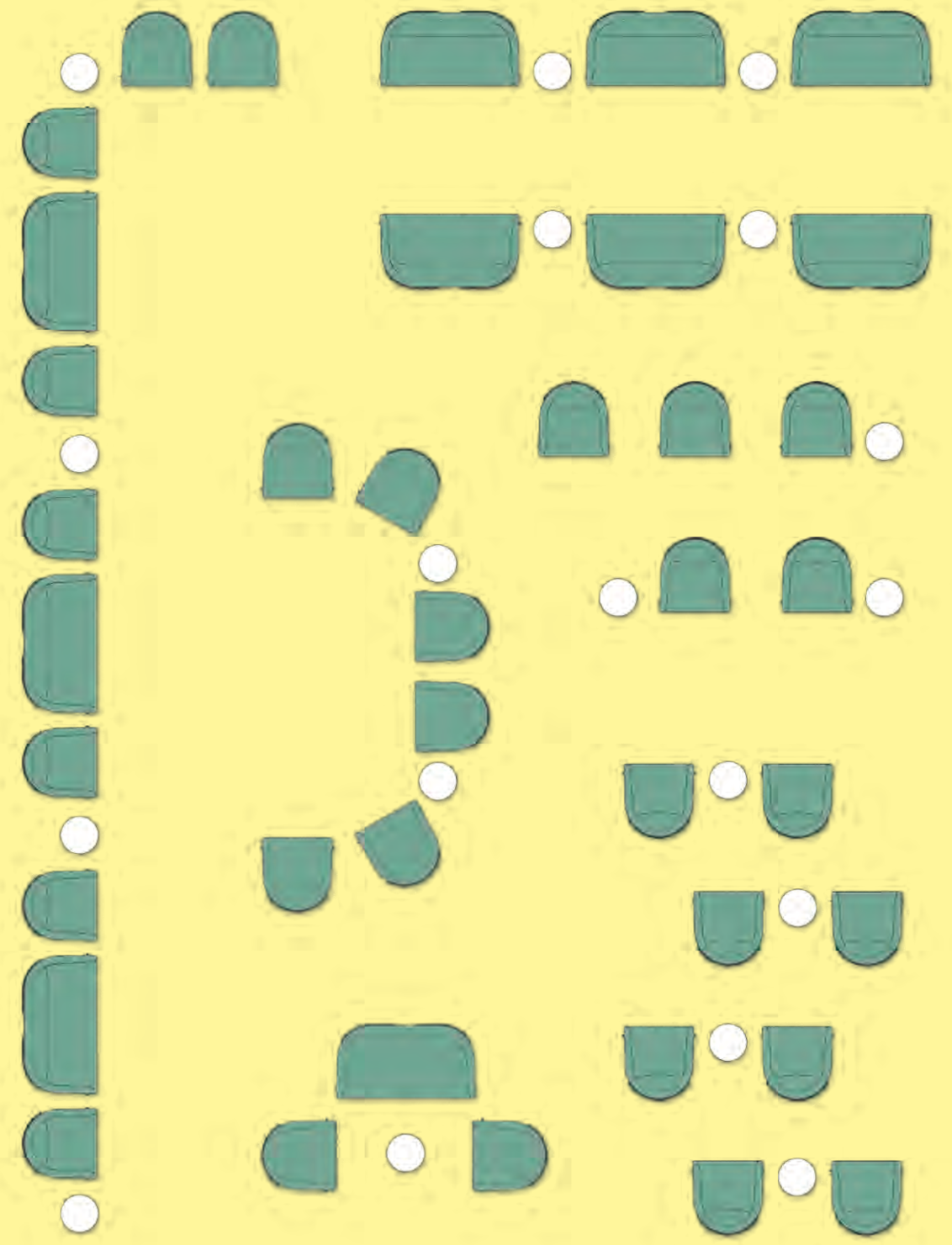





Archipelago

Design:
Monica Förster
2012

A padded seating system, small islands that can be combined or attached together in groups, creating new landscapes that can be reconfigured as desired. Instantly usable in multiple combinations, from organic shapes to more traditional compositions, to meet various needs, from offices to waiting rooms, lounges and domestic environments.

Sistema di sedute imbottite, piccole isole che si possono accostare o agganciare in gruppi, creando nuovi paesaggi riconfigurabili. La fruizione è immediata e le combinazioni sono molteplici, da forme organiche a composizioni più ordinate, per rispondere alle diverse esigenze di interior in uffici, sale di attesa, lounge, ambienti domestici.





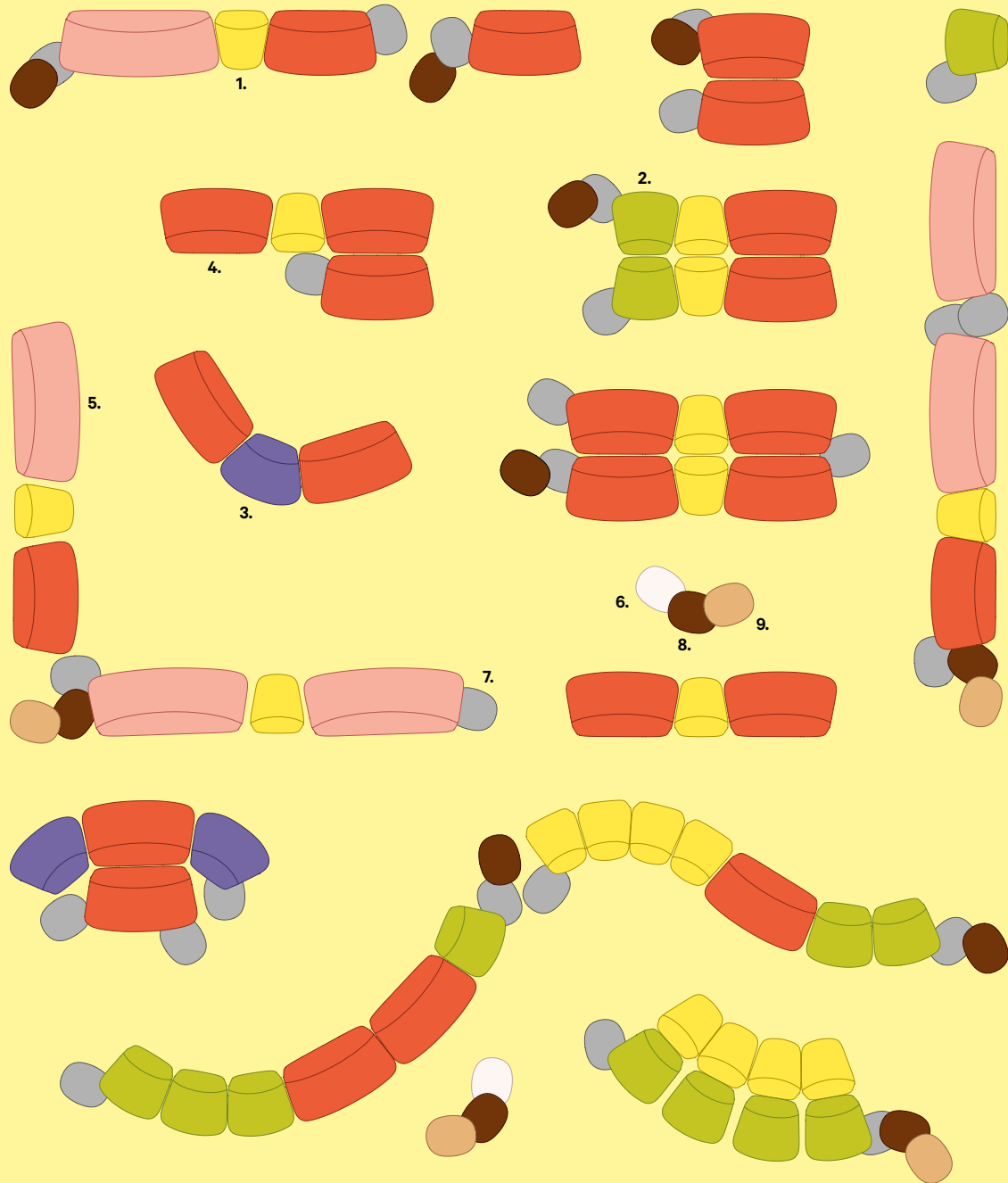

1. Small armchair
2. Medium armchair
3. Large armchair
4. 2-seater sofa
5. 3-seater sofa
6. Free-standing table
7. Low coffee table
8. Medium coffee table
9. High coffee table

1. Poltrona piccola
2. Poltrona media
3. Poltrona grande
4. Divano 2 posti
5. Divano 3 posti
6. Tavolino free-standing
7. Tavolino basso
8. Tavolino medio
9. Tavolino alto

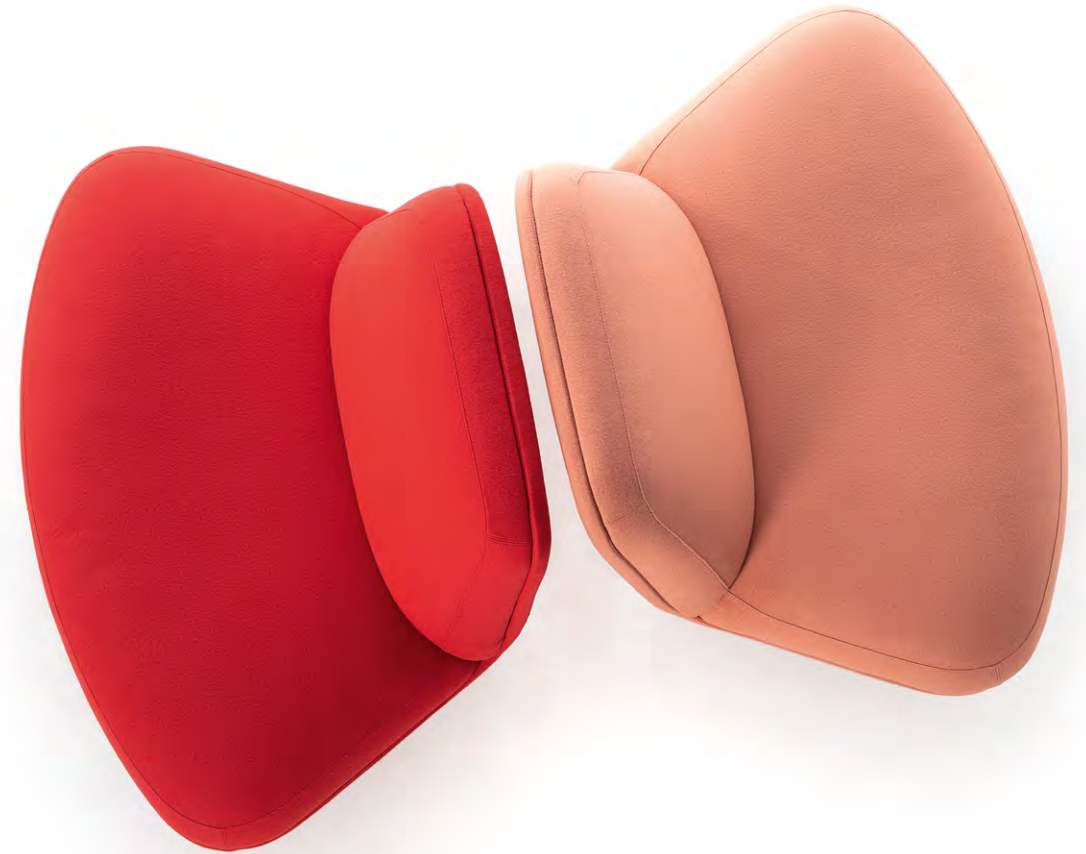



Pons

Design:
Rodolfo Dordoni
2011

This system of beam based sofa is characterised by modularity, easy assembly and extreme flexibility, combined with a high level of comfort obtained through the use of different densities of padding. The universal assembly allows installation of a variety of seats, high or low backrests, and tables. The components can create unlimited layouts, resulting in a vast number of configurations to suit any setting.

Sistema di divani su barra caratterizzato da modularità, facile assemblaggio ed estrema flessibilità, unitamente ad un elevato comfort grazie alle imbottiture a densità differenziata. La serie di agganci universali accoglie liberamente diverse tipologie di seduta, schienali alti o bassi e tavolini. Gli elementi possono essere collocati indifferentemente nelle diverse posizioni permettendo di realizzare le più svariate tipologie di layout e di adattarsi ai cambiamenti degli spazi dove è collocato.



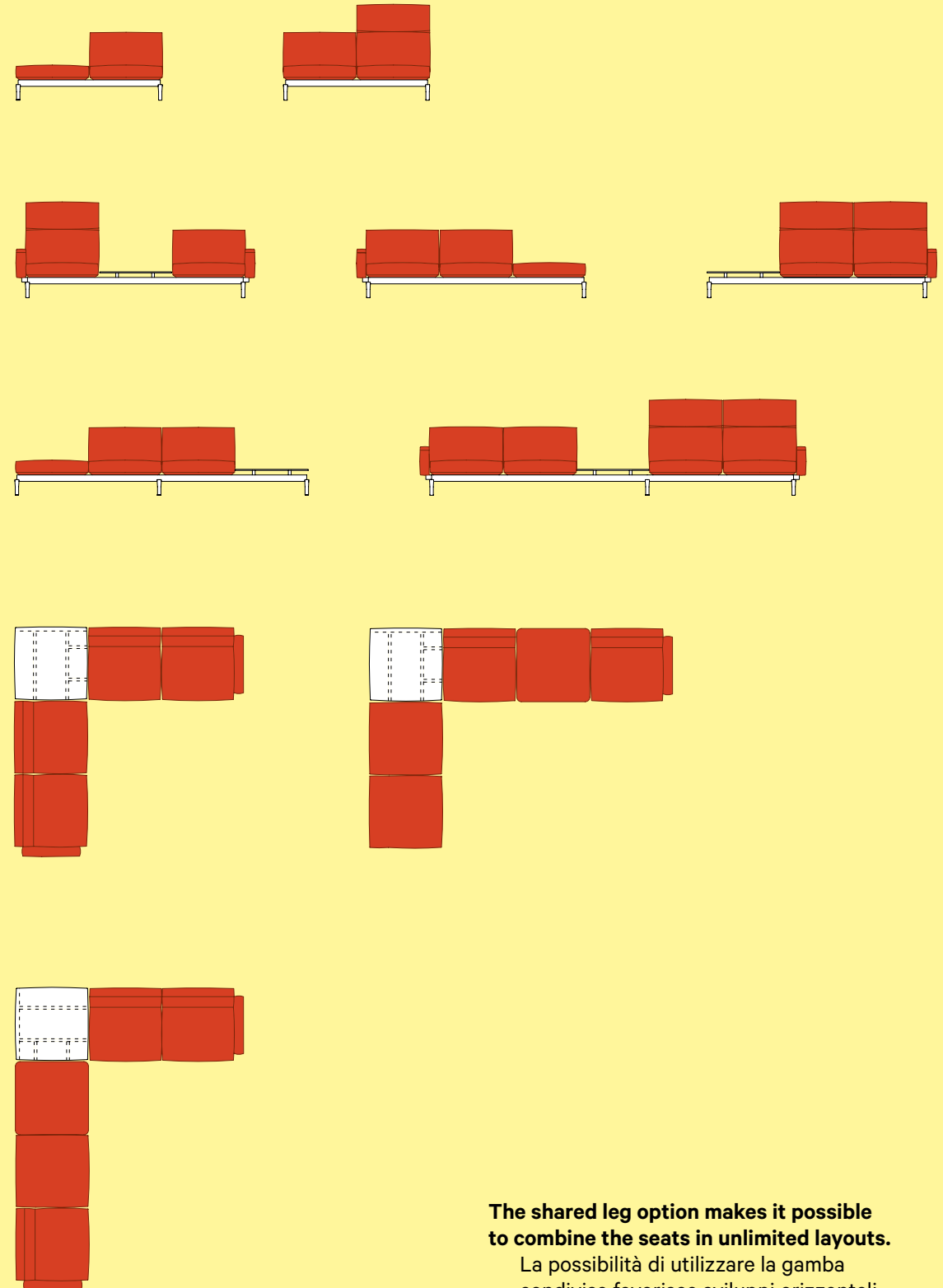

The shared leg option makes it possible to combine the seats in unlimited layouts.
 La possibilità di utilizzare la gamba condivisa favorisce sviluppi orizzontali pressoché infiniti.



Todo Modo

Design:
Jean-Michel Wilmotte
 1993

A contemporary Ottoman with a rotating and completely reversible backrest. The sofa system was born from the 1993 project for the Louvre, from the idea of setting up the rooms with a seat designed to allow visitors the viewing of artworks on every side. Today, Todo Modo finds space in waiting lounges, reception and hospitality areas, offices and co-working environments. Made with dark grey painted metal parts, it is padded with polyurethane foam covered with fabric or leather.

Un'ottomana contemporanea con schienale dal movimento rotatorio e completamente reversibile. Il sistema di divani nasce dal progetto del 1993 per il Louvre, dall'idea di allestire le sale con una seduta pensata per consentire la visione delle opere d'arte da ogni lato. Todo Modo trova oggi spazio all'interno di lounge di attesa, aree reception e accoglienza, uffici e co-working. Realizzata con parti metalliche a vista verniciate opache grigio piombo, ha l'imbottitura in schiuma poliuretana rivestita di tessuto o pelle.





Interior of the Grand Louvre in Paris furnished in 1993 with Todo Modo.
Interno del Grand Louvre a Parigi, arredato nel 1993 con Todo Modo.

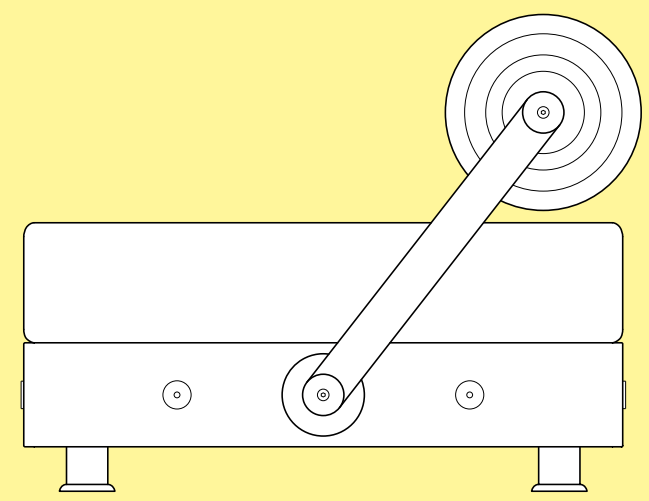
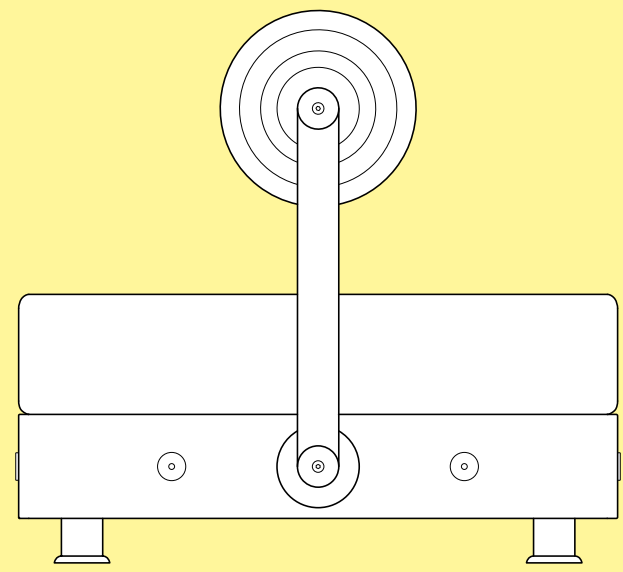
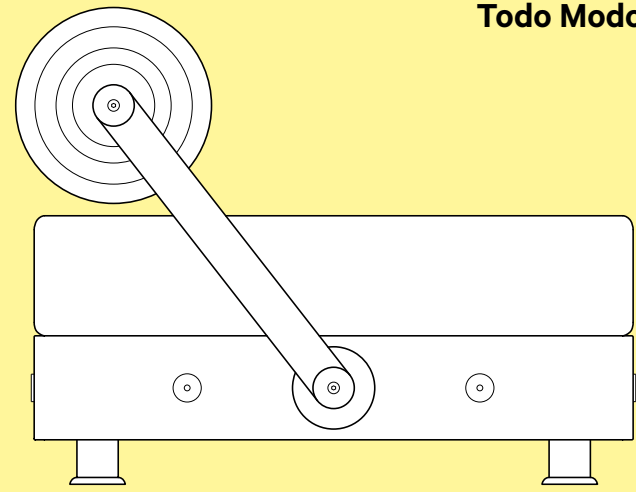
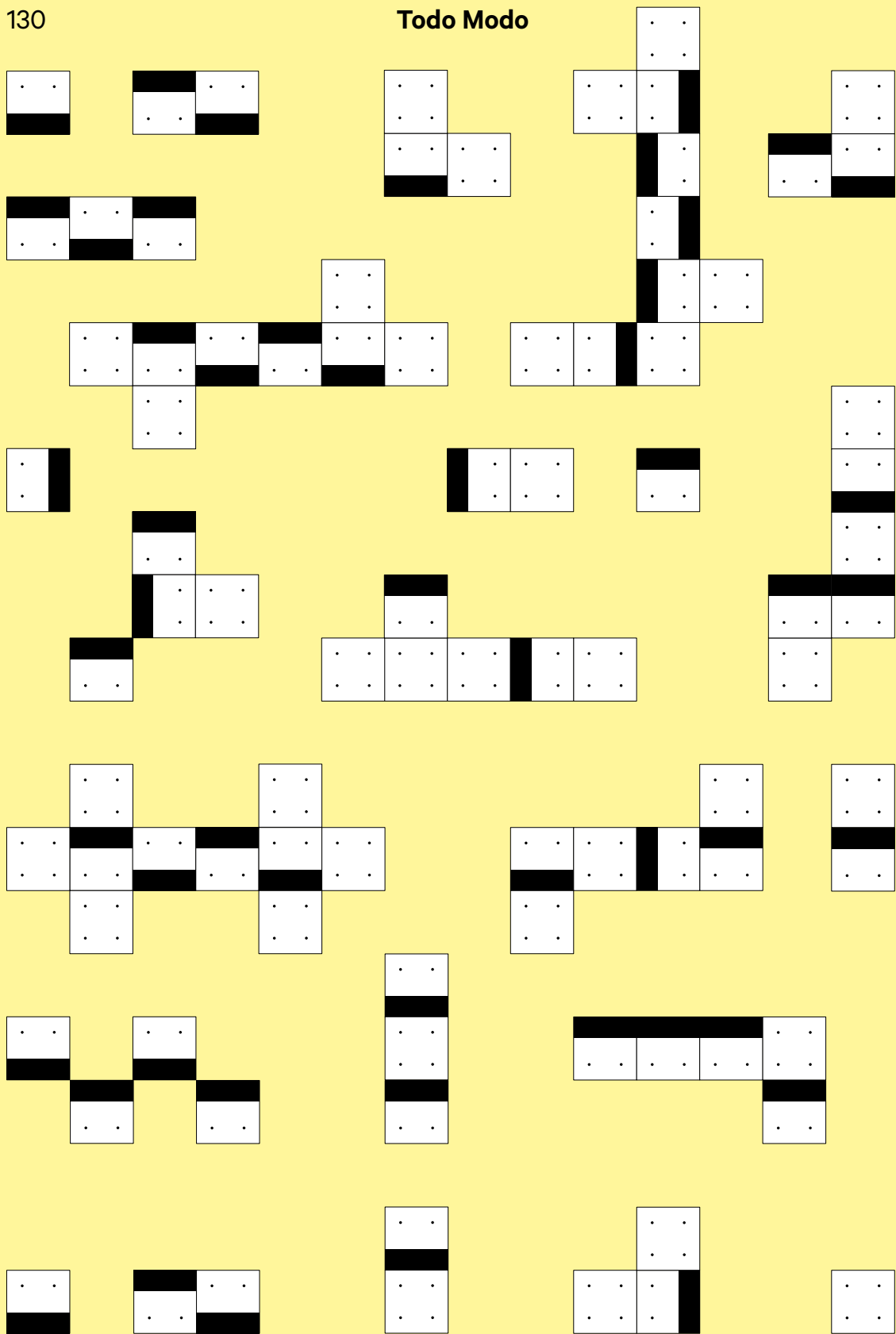



P32

Design:
Oswaldo Borsani
1956



Considered the “natural comfort centre”, the P32 armchair is not only able to swivel and return automatically to its original position, but also incorporates a backrest pivot mechanism. The freedom of the swivel movement makes it suitable for relaxation and conversation in offices, waiting rooms and lounges.

Definita come «il centro naturale della comodità», P32 è una poltrona girevole, con ritorno automatico e meccanismo basculante dello schienale. La caratteristica libertà nel movimento rotatorio la rende adatta al relax e alla conversazione per ambienti ufficio, accoglienza e lounge.





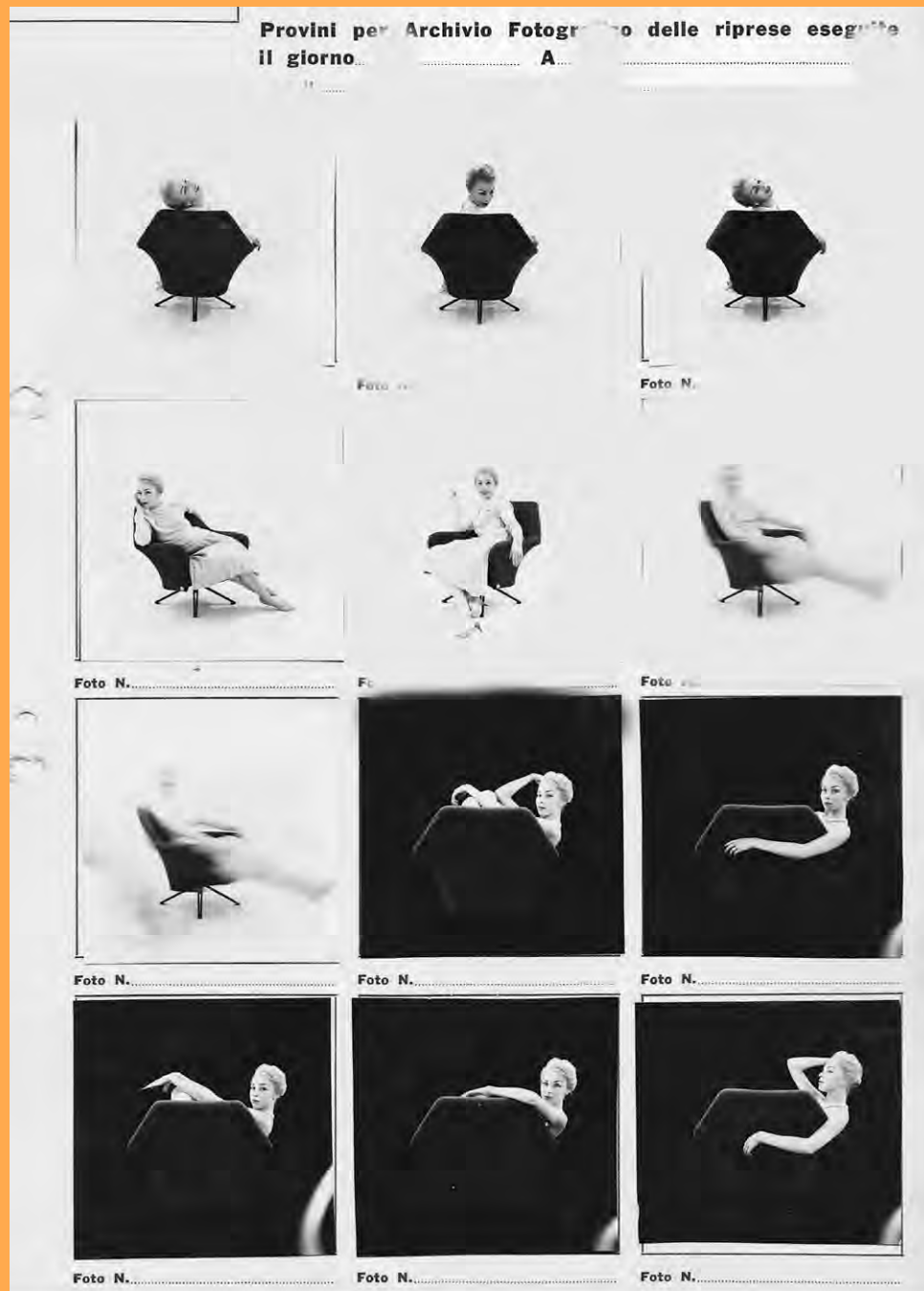

1956. Photographic specimens.
1956. Provini fotografici.



P40

Design:
Oswaldo Borsani
1955

The chaise longue par excellence: the design goes beyond the conventional fixed, bulky armchair to offer a smaller solution with a handy fan-shaped tilt system which holds the occupant securely in all positions until it closes. Completely adjustable in movement, it features a removable footrest and headrest, and flexible armrests. Orio Vergani describes it as “a quick, essential armchair, elementary like the first sum: one and one is two. It offers its curves for navigating dreams, for the delights and recuperation afforded by relaxation.”

Chaise longue per eccellenza: supera la tradizionale poltrona relax fissa e ingombrante, per creare una soluzione di dimensioni ridotte che, attraverso un agevole sistema d'inclinazione a ventaglio, accoglie il corpo in tutte le posizioni fino a chiudersi. Completamente regolabile nei movimenti, è dotata di poggiatesta e poggiapiedi estraibili e braccioli flessibili. Orio Vergani la descrisse come «una poltrona veloce, essenziale, elementare come la prima addizione: uno più uno, due. Offre la sua curva alla navigazione dei sogni, alle delizie e al ristoro del rilassamento».



D70

Design:
Oswaldo Borsani
1954

A patented sofa bed, D70 is the design manifesto for the wishes of Oswaldo Borsani: an item of furniture which is original, autonomous and elegant in form, but technical and industrial in production. The mechanism allows the sofa to be opened out until it completely reverses - an iconic design solution which allows the backrest to open to any angle, even to make a bed.

Divano-letto brevettato, è il manifesto progettuale della volontà di Oswaldo Borsani di creare un elemento d'arredo originale, autonomo ed elegante nella forma, tecnologico e industriale nella produzione. Il meccanismo che consente l'apertura totale fino alla completa reversibilità, diventato ormai una soluzione emblematica nella storia del design, rende possibile qualsiasi inclinazione dello schienale rispetto al sedile fino a farne un letto.





P40, D70



P40, D70



Superimposed images of a model showing three different use and positions of P40 armchair.
Immagini sovrapposte di una modella in posa su P40, mostrandone tre diversi usi e posizioni.

Superimposed images of the D70 sofa showing the different possible positions.
Foto sovrapposte di D70 che illustrano tutte le possibili posizioni.



The D70 mechanism.
Il meccanismo di D70.



With a history that began in 1953, Tecno combines an artisanal culture with industrial methods, knowledge of materials, and innovation, creating distinctive interior architecture and products that have become icons of design. The company is leader in conceiving and producing furnishings, partitions, and seating systems for offices, collective settings, and mobility spaces, maintaining the promise of quality and performance at any scale – from individual objects to major projects.

Con una storia iniziata nel 1953, Tecno integra la cultura artigianale con le logiche industriali, la conoscenza dei materiali e l'innovazione dando vita ad architetture d'interni distintive e a prodotti diventati icone del design. L'azienda è protagonista nell'ideare e produrre arredi, pareti divisorie e sedute per il lavoro, la collettività e la mobilità mantenendo su ogni scala - dall'oggetto singolo alla grande commessa - la promessa di qualità e performance.

With offices in Milan, Paris, London, and New York and a network of partners, Tecno realizes unique projects in terms of both aesthetics and technical characteristics. Architects and contractors seek its expertise in the management of medium and large worksites for offices, institutional spaces, stations and airports, lounges and hospitality facilities at the local or international level.

Attraverso le proprie sedi di Milano, Parigi, Londra, New York e una rete di partner, Tecno realizza progetti unici sia sotto il profilo estetico che per caratteristiche tecniche e la sua expertise è scelta da architetti e contractor per la gestione di cantieri di medie e grandi dimensioni a livello internazionale per uffici, filiali, istituzioni, stazioni e aeroporti, lounge e hospitality.

Furnishing of the European Parliament in Brussels, the Palais de Justice in Paris, Schipol Airport in Amsterdam, Tullamarine Airport in Melbourne, the British Museum in London, and the headquarters of Furla in Milan, Moleskine in New York, and the National Bank of Kuwait are just a few of the company's notable commissions.

Interventi progettuali quali le aule del Parlamento Europeo a Bruxelles e il Palazzo di Giustizia a Parigi, l'aeroporto di Schiphol ad Amsterdam e Tullamarine a Melbourne, il British Museum a Londra, e uffici come le sedi di Furla a Milano, Moleskine a New York e National Bank of Kuwait, sono solo alcuni tra i progetti speciali realizzati dall'azienda.

With 47 industrial patents, projects completed in 45 nations, 5 Compassi d'Oro awards and various international honors, Tecno embodies a pioneering vision and a new design idiom, envisioning an innovative way to imagine and build. On this ethical rather than design foundation, the company has obtained the ISO 9001 and ISO 14001 certification, can supply FSC® certified products (licence FSC-C171395) and with its collections it can contribute LEED® credits.

Con 47 brevetti industriali, realizzazioni in 45 nazioni, 5 Compassi d'Oro e diversi riconoscimenti internazionali, Tecno incarna una visione pionieristica e un linguaggio nuovo, mostrando un modo innovativo di immaginare e costruire. Su questa base etica prima che progettuale, l'azienda è certificata ISO 9001, ISO 14001, può fornire prodotti certificati FSC® (licenza FSC-C171395) e con le sue collezioni può contribuire ai crediti LEED®.

1MP10370
09.2024

Coordinated by

Tecno Marketing & Communication Dept.
marketing@tecnospa.com

Graphic design

Tassinari/Vetta
Paolo Tassinari, Fabio Furlanis, Maddalena Piana

Print

Tipolitografia Scaletta Srl

Collaborators

Umbrella

Photos

Germano Borrelli
Renaud Callebaut
Alessandra Chemollo
Tilde De Tullio
Ruud Emmerich
Forms+Surfaces
Jill Tate
Mathieu Lee Vigneau
Max Zambelli
David Edwin Zanardi
Zone Creative
Richard Kai

Post-production

Azimut

Render

Bieffe Rendering

Tecno S.p.A.

Piazza XXV Aprile 11
20154 Milan – Italy
E info@tecnospa.com
T +39 031 75381

Factory

Via Milano 28
22066 Mariano Comense – Italy
FSC® License FSC-C171395

Offices

Milan / Paris / London / New York

tecnospa.com

